

**SECTION 9**

**Doorset Coordination**





### **Introduction:**

This document provides for general guidance with regard to the coordination of bespoke doorsets. The document includes recommendations with regard to the reference points generally used within the industry for the purpose of communicating dimensional information and for a common language for use by all parties concerned with the design, manufacture and installation of bespoke doorsets.

Experience suggests that the coordination of doorsets with floor levels can be particularly difficult when considering regulations relating to threshold gaps and the possibility that the actual thickness of floor finishes may not be known at the time of manufacture of the doorsets. One method (*General Method*) suggests the accommodation of variations in floor levels by way of limited site adjustments. Where the precise alignment of doorset components between adjacent doorsets in a building is a factor for consideration, this document also suggests a method (*Precision Method*) that can provide for this.

**NOTE:** For the purpose of this document, the term 'Sub Floor Finish' is used to describe the floor level before the application of floor finishes. The sub floor levels may include screed, chipboard or floor boards etc.

For some performance applications e.g. fire performance, there are limits to the maximum approved doorset size and to the minimum size of frame section that can be used, otherwise Architects and Designers are generally provided with generous scope for the use of doorsets to meet their design requirements.

'Standard doorsets' are manufactured to designs determined by the manufacturer and produced without knowledge or consideration of the particular location in which they might be used. These are typically supplied through builders merchants with the majority of doorsets in this sector being used in the domestic housing market.

'Bespoke doorsets' are purpose made to suit a particular location in a particular building and are generally manufactured and supplied in accordance with the terms of a particular contract. Sizes and aesthetic appearances are generally determined by an Architect (or Designer) who will also specify performance requirements to the satisfaction of the Regulations applicable to the building.

Standard doorsets should comply with the dimensional requirements of BS4787 Part 1. Whereas BS4787 Part 1 might be a useful standard for the manufacture of standard doors, it has its limitations for bespoke applications. In particular:

- Architrave is not described in BS4787 Part 1 and there are no considerations with regard to the installation of the doorsets into the building.
- Doorsets with flush over panels are not considered.
- Double action doorsets are not considered.

The purpose and intended use of the building will have an influence on design requirements and the manufacturers of bespoke doorsets are accustomed to working closely with designers and contractors to provide for coordinated products to meet the requirements of a particular project.

Generally the important requirements are:

- The doorsets should reasonably satisfy the aesthetic requirements of the Designer.
- The doorsets should provide for the performance requirements for each location to the satisfaction of the Regulations and specifications applicable to the particular building.
- The doorsets should fit the particular opening in the particular building into which they are to be installed.

To satisfy these requirements there needs to be a high level of coordination between the doorset manufacturer and other parties involved with the installation.

- Openings in walls and partitions need to be properly prepared to suit the required doorset design and dimensions.
- Floor finishes and floor levels need to be determined to ensure that the doors clear the floor during the swing of the door and that the under door clearances satisfy the standards and regulations applicable to any related performance.
- The installation of the doorset needs to be carried out by competent installers, particularly where 'performance' doorsets are required.

**NOTE 1:** The primary performance requirement for any doorset is to provide for a means for 'traffic' to pass from one side of a wall to the other. The term 'performance doorset' in this document relates to secondary performances that may be attributed to the same location e.g. fire, smoke, sound attenuation, security etc.

**NOTE 2:** If a doorset does not work satisfactorily in its primary role then it is unlikely that any secondary performance requirement will be achieved.



### **Introduction contd:**

For bespoke projects, the doorset designs and the coordination of the doorsets will be determined by the Designer with due regard to the performance requirements for particular locations in a building with reference to relevant standards and regulations. Considerations should include for the following:

- The nature of the structure into which the doorset is to be fitted including provisions for installation fixings.
- The dimensions of the opening in the wall or partition to receive the doorset.
- The required sizes of the door leaves (**NOTE: May be subject to performance limitations**).
- The extent to which there is a requirement to align doorset elements between adjacent doorsets in the same building.  
(**NOTE: Doorset elements can include door leaf height levels, glazing aperture levels, hardware positions etc.**)
- The work to be carried out by the builder in preparation to receive the doorsets.
- Floor finishes and levels.

The following advice provides for guidance for Designers and describes recommended coordinates for the purpose of communicating dimensional information and conventions to be applied in the absence of specific design instructions to address the particular issues discussed in this document.

The conventions are based upon guidance to be found by reference to BS4787-1 : 1980 Incorporating Amendment Nos. 1, 2 & 3 '*Internal and External wood doorsets, door leaves and frames - Part 1: Specification for dimensional requirements*' and BS6750 : 1986 '*Modular coordination in building*'. However, the conventions are applied in a manner that provides for bespoke doorsets of any size (**subject to performance limitations**) that may be required by the Designer based upon the customs and practices of the bespoke door industry.

Use of doorset designs that use separate architrave provide for greater flexibility and are less demanding with regard to the necessity for pre manufacture planning. Frame designs using integral architrave or 'nibs' or which use 'shadow gaps' around the installed frame require more careful planning in advance of manufacture.

BS4787 Pt. 1 : 1980 and BS EN 12519 : 2004 refer to the use of a coordinating dimensions. The relevant standards will show that the coordinating dimensions relate to positions in space between the doorset and the surrounding structure. The method described in this document refers to the '**Prepared Opening**'.

This is the opening size in the wall or structure to be prepared by the builder to receive doorsets of the desired dimensions and provides for a clear separation between the builders work and the work to be done by the doorset installation contractor.

Frame sectional dimensions suggested in this document are based upon the economic use of raw material sizes for timber. Frame jambs and heads using planted doorstops can be moulded using ex. 1½in. material while frames with moulded doorstops can be manufactured using ex 2in. raw material. This results in maximum finished frame sections of 32mm and 44mm respectively after allowing for trimming and finishing of the timber. Frames of different finished sectional dimensions may be used (**subject to performance limitations**). A minimum 32mm finished frame section may be an essential requirement for some performance doorset designs. For any given structural opening size, where the frame section dimension is greater than 32mm the door leaf sizes may be reduced to provide for coordination with the building. Where the frame section dimension is less than 32mm it is recommended that the door leaf sizes remain the same but with increased packing between the frame and the surrounding structure.

When installed, it is recommended that the doorset designs should provide for a minimum of 5mm cover of the surrounding structure by the architrave.

**NOTE: The term 'Architrave' in this sense can apply to a separate architrave section or an integral architrave (nib).**

The determination of precise finished floor levels in advance of manufacture of the doorsets creates a major difficulty in determining doorset component height requirements. The general method suggested in this section provides for a site adjustment allowance providing for minimum clearance of 20mm from the bottom of the door to the bottom of the frame jamb (**when used without sills**). This allows for the frame jambs to rest upon the sub floor (**floor level before the application of floor finishes**) permitting the use of floor finishes up to 17mm thickness to leave the 3mm under door operating tolerance required (**where threshold seals are not used**) by reference to BS4787 Pt.1 and BS5588 - 11 or BS9999 : 2008 (**for smoke containment doorsets without threshold seals**).

**NOTE: Unless a four sided frame (with sill) is used, the doorset manufacturer cannot control the threshold gap for an installed doorset. However, most manufacturers will provide for a standard trimming allowance by controlling the dimension from the bottom of the door leaf to the bottom of the frame jambs. Each manufacturer may offer their 'standard' provisions in this regard. It is important that Specifiers / Buyers should ensure that these provisions suit the requirements for the particular project and agree variants, if necessary in advance of manufacture.**



### Introduction contd:

Based upon a trimming dimensions dimension of 20mm from the bottom from the bottom of the door to the bottom of the frame jamb: Where the applied floor finishes are less than 17mm, the frame jambs can be reduced on site to provide for a minimum 3mm clearance over the actual floor finish within the installation tolerances provided for by use of a 44mm section architrave.

**NOTE:** A 44mm section architrave provides for the economic use of timber allowing for the use of ex. 2in (50mm) raw material with minimal wastage. Increased architrave dimensions provide for increased installation tolerances.

Where soft floor finishes (e.g. carpet) are greater than 17mm it is necessary to either specify an undercut requirement or to trim the bottom edge of the door leaves on site to provide for the under door operating clearance.

**NOTE:** Where soft floor finishes are used, it is recommended that jambs extend down to the sub floor level. Where hard floor finishes (e.g. ceramic tiles) are used, the frame jambs can be reduced with the doorset fitted after laying the tiles.

The general method described above has the advantage of permitting the manufacture of doorsets in advance of final decisions with regard to applied floor finish dimensions. Whereas this method is satisfactory for use with doorset using separate architrave of suitable dimensions for the purpose of accommodating tolerances, there can be some misalignment of doorset components between adjacent doorsets following on site adjustments to suit actual floor finish thicknesses.

Designers may prefer to use doorset systems with integral architrave. Alternatively, doorset designs using 'shadow gap' features (*without architrave*) may be desired. A requirement to provide for the precise alignment of doorset elements between adjacent doorset may also be an important design consideration. Where these considerations apply a more precise method for coordination is recommended.

The suggested 'Precision Method' is based upon the use of a building DATUM which is used as a reference by all affected trades.

The DATUM can be shown in project drawings and physically marked in the building for use as a reference by all affected trades including:

- Builder: Construction of Prepared Openings to receive doorsets.
- Doorset manufacturer.
- Doorset Installation Contractor.
- Flooring Contractor.
- Electrical Fittings Contractor. (*for the alignment of wall mounted switches etc.*)
- Other trades required to fit visible products in a coordinated manner.

The DATUM can be set at any height determined by the Designer but for convenience a height of 1000mm above a nominal (hard floor) floor level is recommended. All affected trades can then work independently to a common DATUM reference.

**NOTE:** To satisfy the requirements of Building Regulations - (England & Wales) - Approved Document 'M' and BS8300, glazed aperture location dimensions should relate to the sight line of the glass i.e. the clear glass area after beading. (See page 9.29)

### Precision Method for the alignment of doorsets:

Fig. 9.1

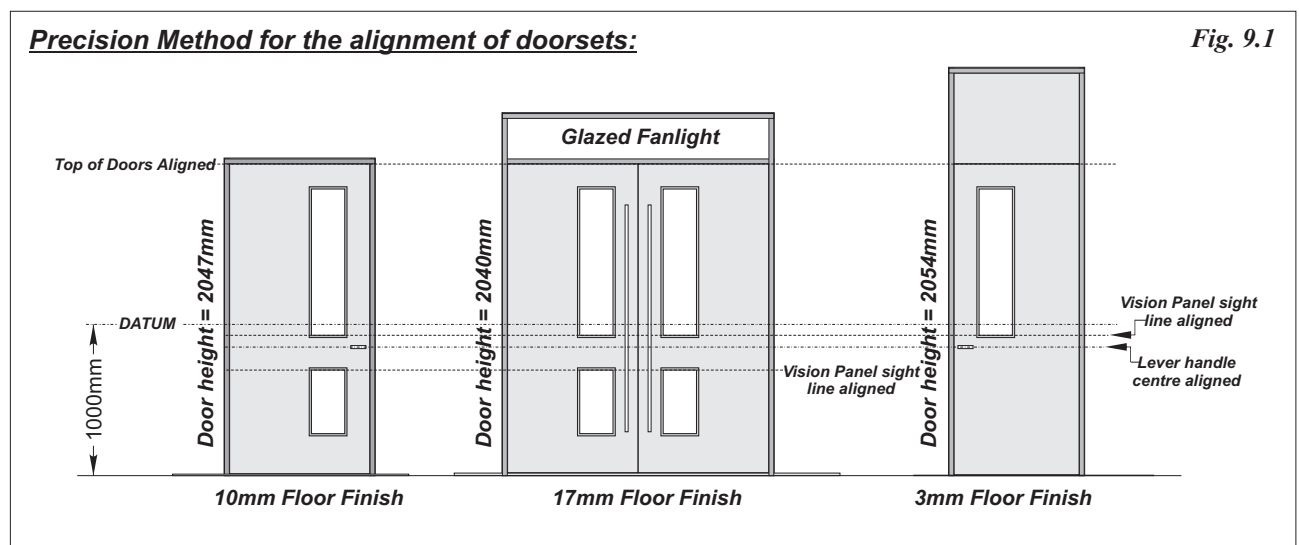



**Doorset Coordination - Prepared Openings**

Fig. 9.2

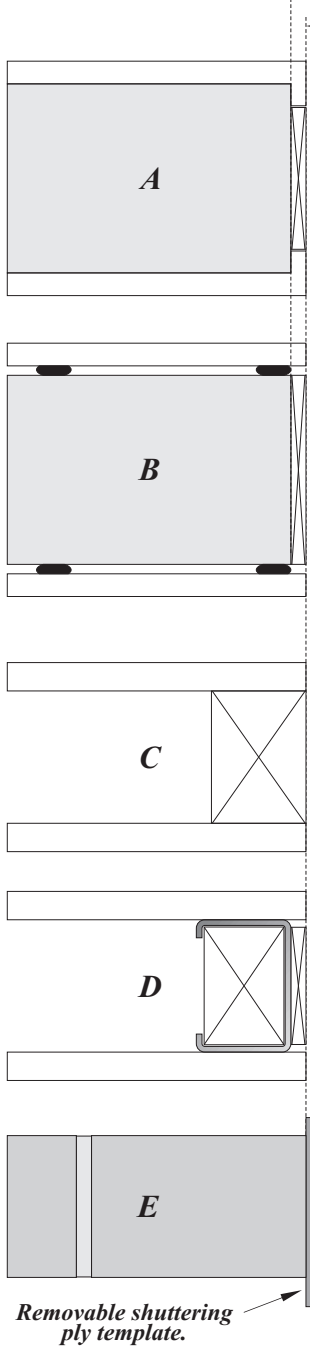
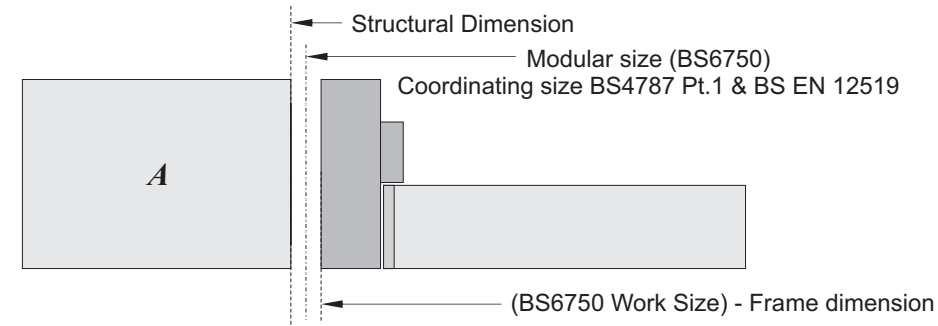

This detail illustrates the relationship between: Structural opening, Modular or Coordinating size, Prepared opening and Work size / Frame dimensions.

The size of the permissible installation gap (*i.e. the gap between the door frame and the surrounding structure*) will vary according to the extent of the architrave cover provided by the particular door frame design. As an absolute minimum, it is recommended that the installation gap should not be less than 3mm at each jamb and 6mm at the frame head. This absolute minimum installation gap is only possible where the opening in the structure is carefully prepared to receive the doorset and is absolutely plumb and square.

**A/** For rendered or plastered block work the render or plaster should be returned around the edges to a ground or sub frame that is less than the finished thickness of the base wall.

**NOTE:** Plaster or render should not be applied to timber grounds or sub frames. The timber ground will absorb moisture from the render / plaster and will swell as a result. Subsequently it is likely that the ground will lose moisture and shrink causing plaster to crack.

**B/** Where masonry walls are faced with plasterboard secured by plasterboard adhesive dabs, the ground or sub frame can be to the full thickness of the base wall.

**C/** Timber stud partition walls can generally be constructed to suit the prepared opening requirements.

**D/** Metal stud partitions can generally be constructed to provide for required Prepared Opening dimensions. However, these can be adjusted by the use of additional sub frames or grounds.

**NOTE 1:** It is recommended that the metal stud is back filled with a timber ground to receive installation fixings. Further, the timber ground will provide for improved stability under fire conditions when used with timber doorsets.

**NOTE 2:** Some metal stud partitions have been successfully fire tested with timber doorsets without the need for additional timber filling of the metal stud. In this case, the doorsets should be installed in reliance upon the partition manufacturers test data using installation fixings for the doorset that comply with the partition suppliers recommendations.

**E/** For fair faced brick or block walls and for other masonry walls one method is to provide for a prepared opening dimension by building the wall to a template that can be removed after construction of the wall.



### Doorset Coordination - Floor Levels

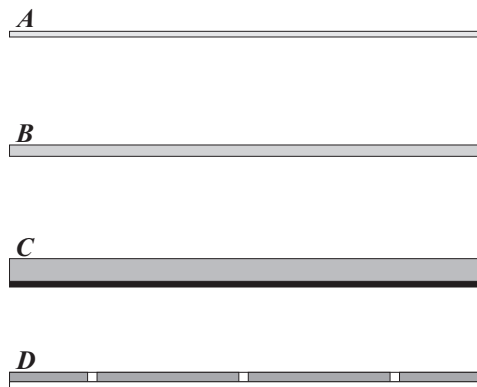
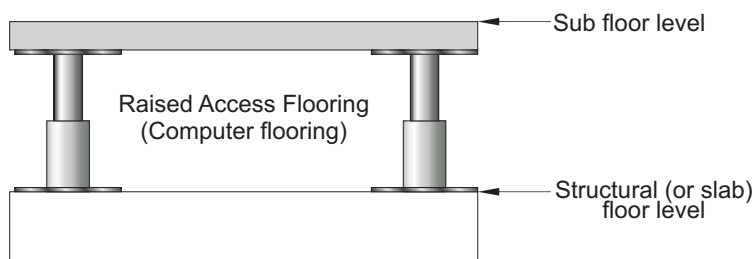
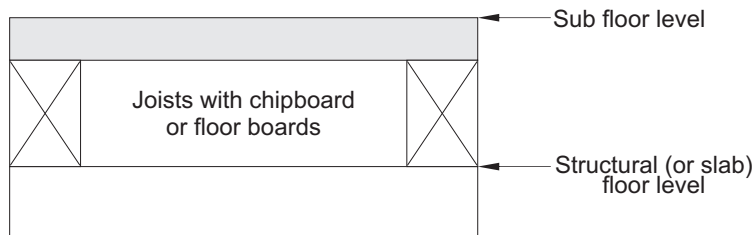
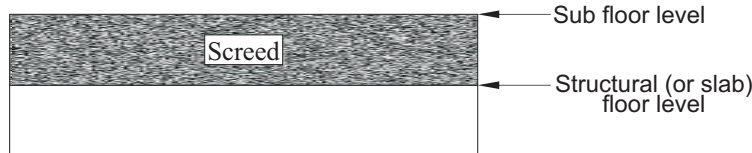
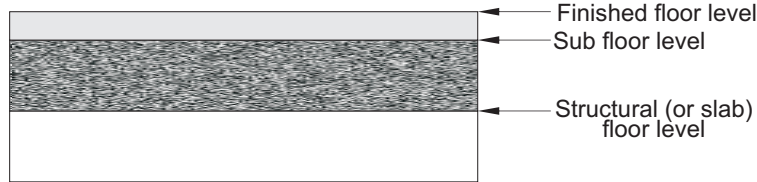

### Floor Levels

Fig. 9.3

There can be 3 floor levels to consider when coordinating doorsets:

- . Structural (or slab) level.
- . Sub floor level.
- . Finished floor level.

Generally for 2nd. fix doorsets the frame jambs rest on top the sub floor level but, the door leaf has to clear the finished floor for the whole swing of the door.

**NOTE:** Where ceramic tile floor finishes are used it is generally recommended that the doorsets are installed after tiling.

For some applications e.g. car parks and some plant rooms a sub floor is not used and the frame jambs rest on top of the Structural (slab) floor level.

It is often the case that the actual thickness of a floor finish is unknown at the time when doorsets are required to be manufactured. Even where the nominal thickness of the floor finish is known, there is often a significant difference between the nominal and actual floor finish.

The coordination of doorsets with floor finishes has proven to be a difficult requirement demanding additional care, particularly where small threshold gaps are required for installed doorsets. e.g. for unsealed threshold gaps for smoke sealed doorsets.

The doorset manufacturer can control the dimension from the bottom of the door leaf to the bottom of the frame jamb but other considerations that are outside of the control of the doorset manufacturer apply with regard to the under door clearance for an installed doorset.

### Floor Finishes:

Various materials of different thicknesses are used as floor finishes. These include :

- A/ Lino, Vinyl & Vinyl tiles.
- B/ Carpet tiles.
- C/ Carpet (with or without underlay).
- D/ Ceramic tiles.

Whereas it is possible to fix many doorset designs into locations where floor finishes have previously been laid it is general practice to install doorsets relative to sub floor levels, with the exception of areas where ceramic tiles are used. It is recommended that ceramic tiles are laid before the installation of doorsets.



**Change of Finished Floor levels:**

Fig. 9.4

**Option 1 - Sub Floor Levels adjusted to suit floor finishes:**

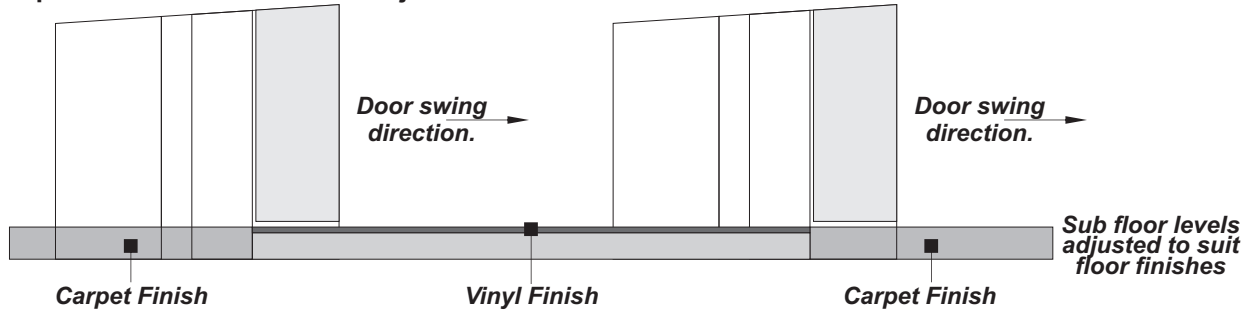

**Option 2 - Variable height floor levels to suit floor finishes:**

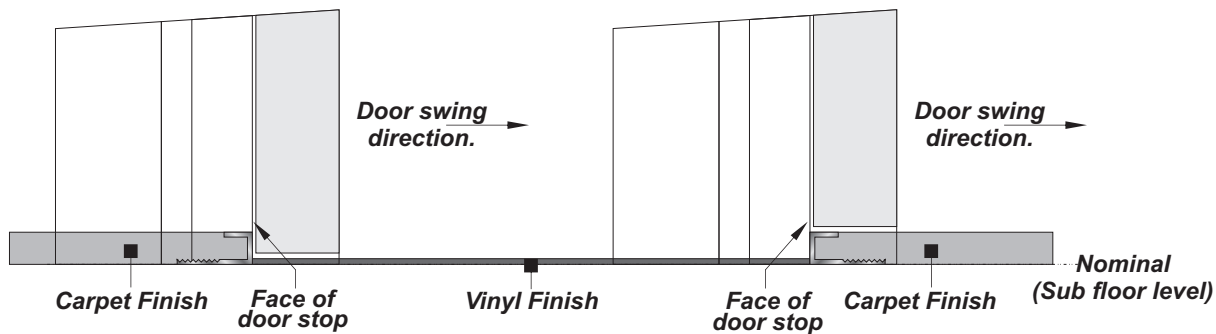

**Change of Floor Finish:**

In many cases the levels for the sub floor will be varied such that the finished floor levels when the flooring is laid will be a constant throughout the building. (**Option 1**).

In other cases the finished floor levels will vary with the possibility that there will be a change of floor finish at the doorset positions. (**Option 2**).

For single action doors it is recommended that the change of floor levels should be planned to align with the face of the doorstop. Alternatively threshold strips may be used. (**Option 2a**). In both cases the floor level should be a constant within the thickness of the door leaf.

Using the General Method suggested in this document, the frame jambs will be adjusted on site to provide for a finished floor level up to 17mm above the sub floor level (**using a 44mm architrave**).

For double action doors it is recommended that the change of floor level should be planned such that the higher floor level extends through the whole thickness of the door. This will ensure that the doors will clear the floor during the whole of the swing.

**Change of Finished Floor levels: Option 2a**

Fig. 9.5

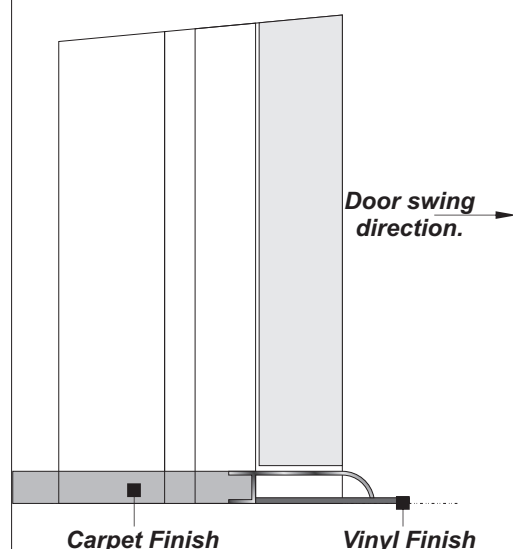

**An alternative method is to use a threshold strip that provides for a level floor to the full thickness of the door leaf.**





### Doorset Coordination - Operating Gaps - Width:

Fig. 9.6

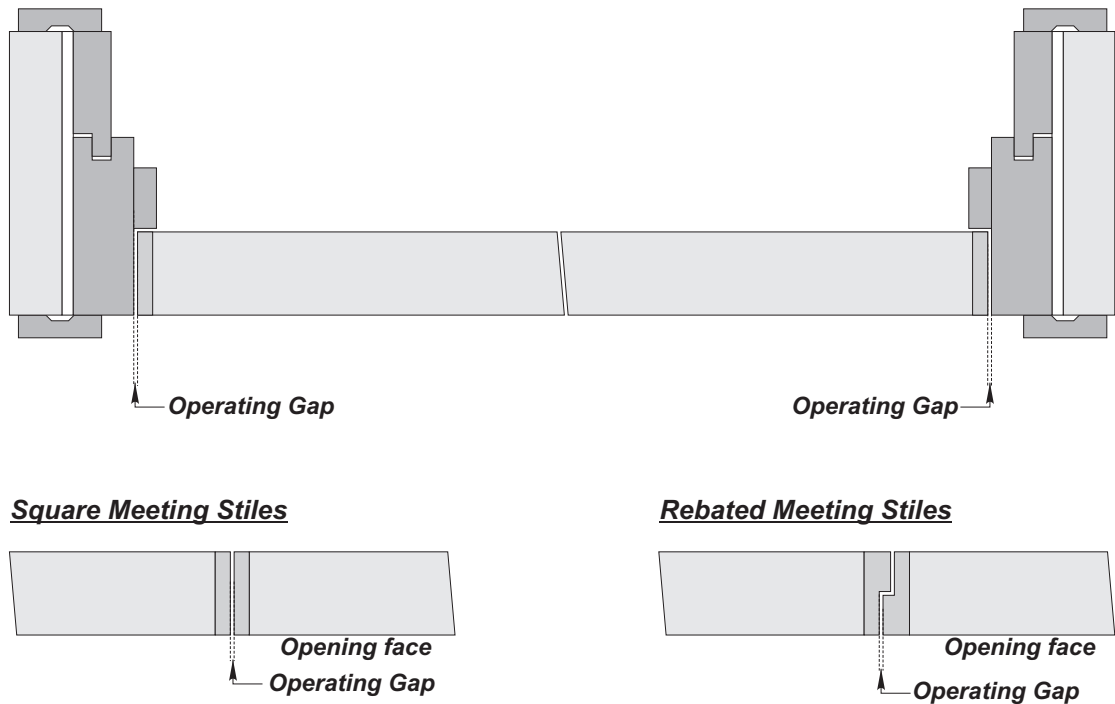

### Operating Gaps - Width.

BS 4787 Pt.1: 1980 Incorporating Amendment Nos. 1, 2 & 3 requires that operating gaps in width should comply with the following:

Door / Frame at Jambs	= Nom. 2mm +1 / - 0.5mm
Meeting Stiles	= Nom. 2mm +1 - 0.5mm

**NOTE:** BS4787 Pt.1 permits variations to operating gaps to accommodate sealing systems e.g. smoke seals.

Operating gaps should be measured from the opening face of the door. (See page 9.32 - Adjusting for 'Door Growth').

**NOTE:** Operating gaps are determined at the time of factory completion of the doorset. Subsequent changes in environmental conditions that influence the moisture content of timber may become apparent by way of variations to operating gaps.

**NOTE:** The maximum / minimum operating gaps approved for installed fire rated doorsets may be defined by reference to 3rd. Party Certification Global Fire Door Assessments related to the particular door leaf construction design.

Unless otherwise specified, manufacturers complying with BS4787 Pt.1 will calculate doorset dimensions based upon a Nom. 2mm operating gap at hanging, closing and meeting stiles.



### Doorset Coordination - Operating Gaps - Height:

Fig. 9.7

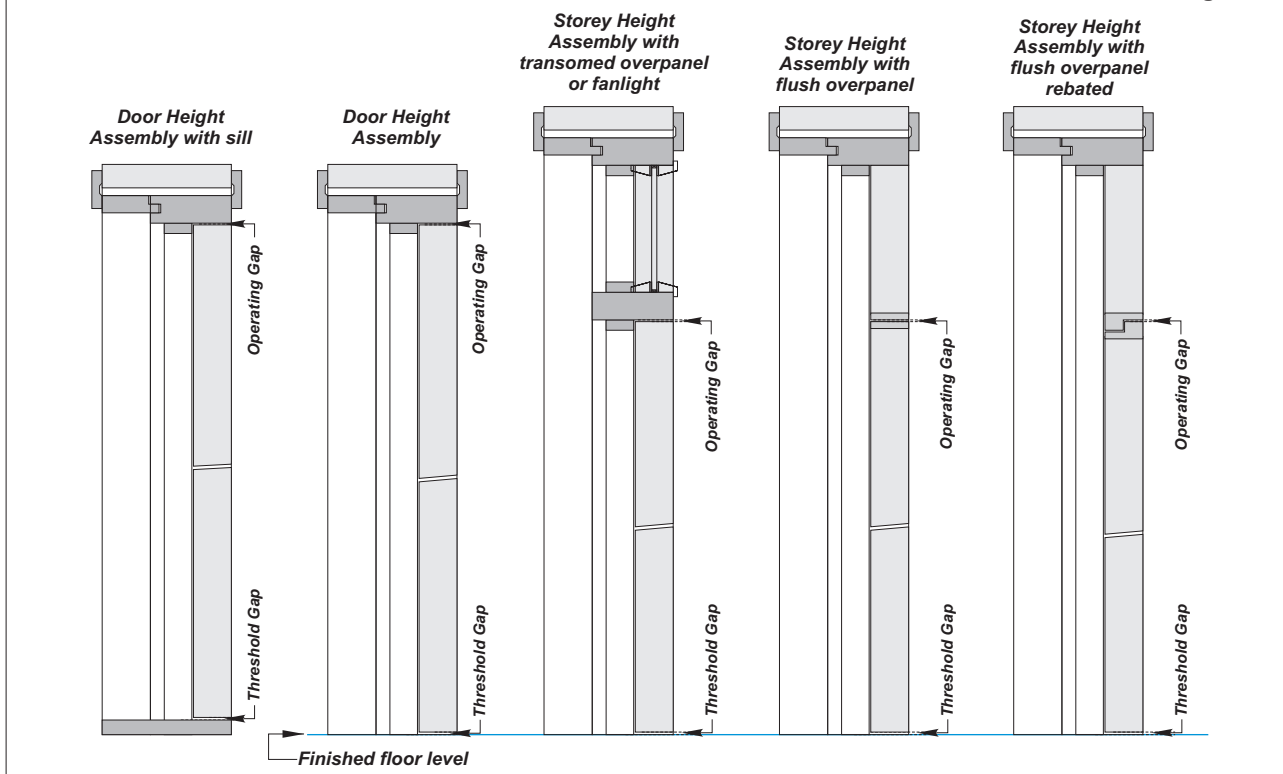

### Operating Gaps - Height.

BS 4787 Pt.1: 1980 Incorporating Amendment Nos. 1, 2 & 3 requires that operating gaps in height should comply with the following:

$$\begin{aligned} \text{Door / Frame at Head / Transom} &= \text{Nom. } 2\text{mm} +1 / - 0.5\text{mm} \\ \text{Threshold - with sill} &= \text{Nom. } 3\text{mm} +1 - 0.5\text{mm} \end{aligned}$$

**NOTE:** BS4787 Pt.1 permits variations to operating gaps to accommodate sealing systems e.g. smoke seals.

**NOTE:** Unless otherwise specified manufacturers complying with BS4787 Pt.1 will calculate doorset dimensions based upon a provision for Door / Frame Head / Transom operating gaps of 2mm at the junction between the door leaf and flush overpanels. (Not defined by reference to BS4787 Pt.1)

Operating gaps at the head of the door should be measured from the opening face of the door. The operating gap at the threshold is the minimum gap at any point within the thickness of the door leaf.

**NOTE:** Operating gaps are measured at the time of factory completion of the doorset. Subsequent changes in environmental conditions that influence the moisture content of timber may become apparent by way of variations to operating gaps.

**NOTE:** The maximum / minimum operating gaps approved for installed fire rated doorsets may be defined by reference to 3rd. Party Certification Global Fire Door Assessments related to the particular door leaf construction.

**NOTE:** For smoke sealed doors, the threshold gap for an installed doorset should be sealed. Where it is impractical to use seals, the maximum gap (above finished floor level - with the door in the closed position) should not exceed 3mm. (BS9999 : 2008).

Unless otherwise specified, manufacturers complying with BS4787 Pt.1 will calculate doorset dimensions based upon a Nom. 2mm operating gap at the head of the door.

Most manufacturers will provide for overpanels with a tight fit (*i.e. zero tolerance*) to frame jambs / heads and transoms unless otherwise agreed at the time of order, on a project basis.

Unless otherwise agreed at the time of order, manufacturers supply doorsets (*without sills*) with a 'manufacturers standard' dimension from the bottom of the door to the bottom of the frame jambs with the intentions that jambs will be reduced on site by the installation contractor to suit individual location requirements.



### **General Method - Doorset Coordination Doorset Widths - Single Action Doorsets:**

- Generally the cover provided by the architrave allows for generous installation tolerances.
- The architrave, when fitted should provide for a minimum 5mm cover over the surrounding structure.
- The prepared opening width in the structure (**or the frame width**) should be calculated to provide for a minimum 6mm installation gap in width (**min. 3mm at each jamb**).
- Prepared openings must be carefully formed and must be plumb and square to receive doorsets.

### **Single Leaf Doorsets - Single Action**

Fig. 9.8

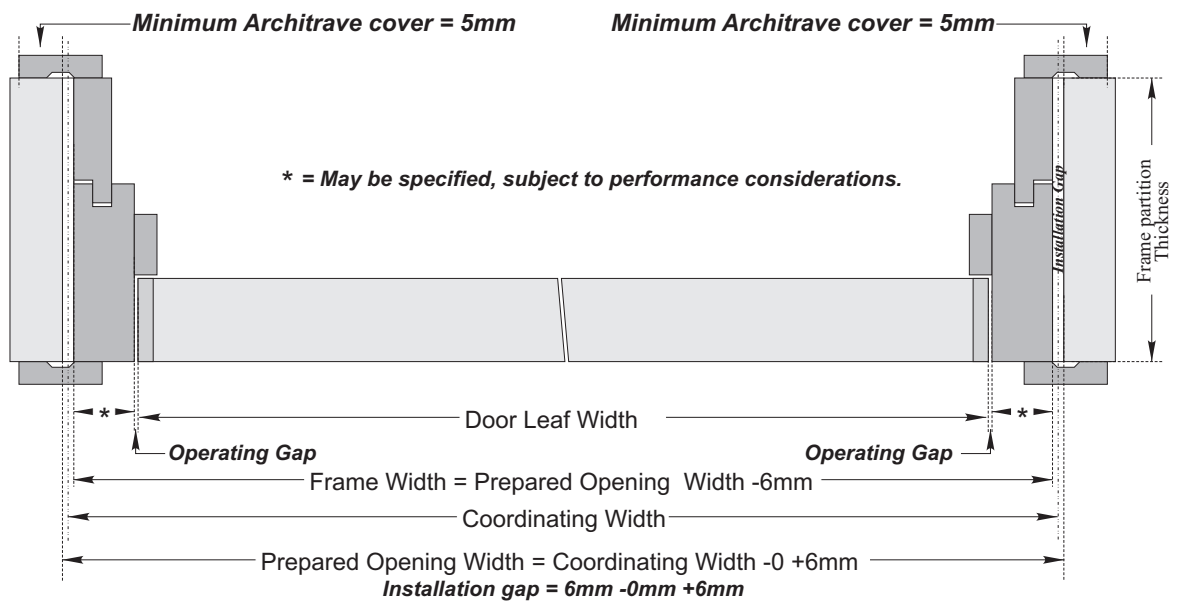

**NOTE:** The installation gap can be increased for frame designs using separate architrave subject to a minimum architrave cover of 5mm over the surrounding structure

### **Double Leaf Doorsets (Pairs) - Square Meeting Stiles - Single Action.**

Fig. 9.9

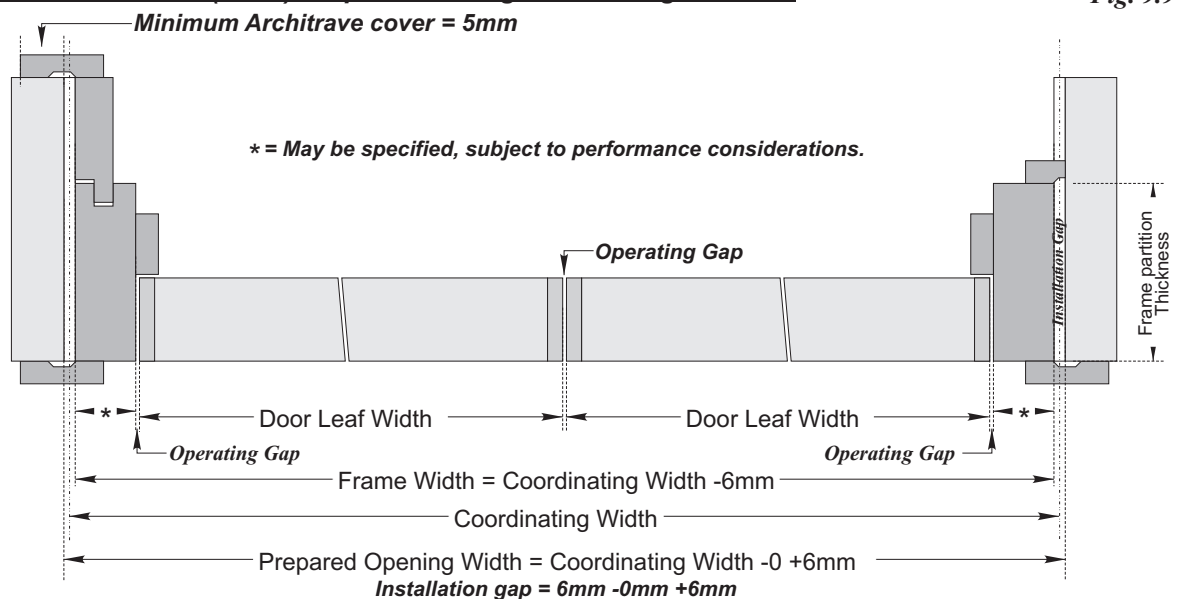

**NOTE 1:** The installation gap can be increased for frame designs using separate architrave subject to a minimum architrave cover of 5mm over the surrounding structure.

**NOTE 2:** Where door leaves of unequal width are required the door leaf width for the large door should be specified together with the frame width. The handing of the large leaf should also be specified. See 'Method of Handing' Page 9.33.



**Double Leaf Doorsets (Pairs) - Rebated Meeting Stiles - Single Action.**

Fig. 9.10

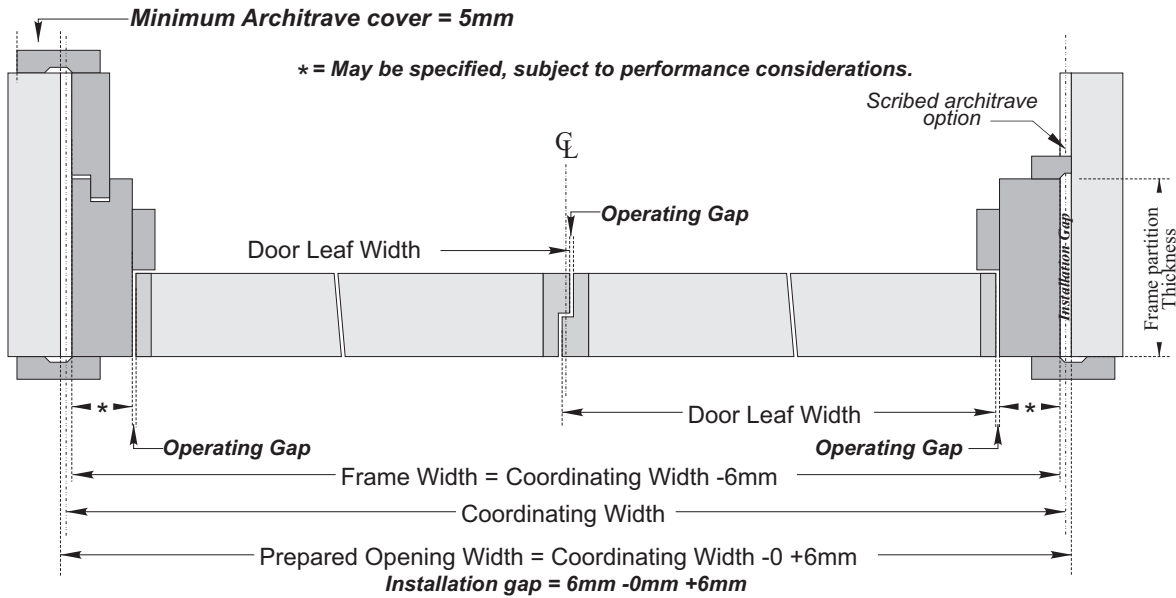

**NOTE 1:** The installation gap can be increased for frame designs using separate architrave subject to a minimum architrave cover of 5mm over the surrounding structure.

**NOTE 2:** Unless otherwise specified requirements for rebated meeting stiles will be satisfied by providing for 12mm rebated meeting stiles achieved by increasing each door leaf width by 6mm. This will essentially mean that the meeting stile gap will be off centre width of the pair on both faces of the doors.

**NOTE 3:** Where required the operating gap can be positioned to show centre width of the pair of doors to one of the door faces. In this event the Designer should specify the door leaf widths necessary to provide for the desired aesthetic effect. In any event the handing for the first opening doorleaf should be specified. See 'Method of Handing' Page 9.33.



### General Method - Doorset Coordination Doorset Heights - Door Height Doorsets - Single Action:

Coordinating doorsets in height is more difficult due to the number of trades involved. The general method described in this detail is suitable for use with frame designs using separate architrave to cover the junction between the frame and the surrounding structure.

This method provides for the site adjustment of frames to suit actual floor finishes for each site location. The frame jambs are sized to provide for the site reduction of frames by up to 17mm while providing for a Nom. 3mm clearance between the bottom of the door and the top of the floor finish to the satisfaction of BS4787 and BS5588-11 or BS9999 : 2008 (*without additional threshold sealing*) for smoke sealed doorsets.

For some performances e.g., smoke sealing, fire performance and sound attenuating performances, the installation contractor should provide for packing between the frame and the surrounding structure. This might require the addition of softwood grounds to be applied to the top of the frame head or the underside of the structure. (See Page 9.22).

**NOTE:** See Section 14 and BS8214 : 2008 for Fire Rated doorsets.

The method of adjustment and dimensional advice described in this document will provide for the minimum 5mm cover over the surrounding structure when used with a nom. 44mm architrave. Designers may vary these details but with a possible requirement for increased size architrave.

As frames may be reduced on site (*by up to 17mm + any additional trimming allowance provided for by the doorset manufacturer*) to suit actual location requirements, particularly floor finishes, this method does not provide for the alignment of doorsets or doorset elements (e.g. glazed apertures, hardware) between adjacent doorsets where different floor finishes are used.

### Door Height Doorset - Single Action

Fig. 9.11

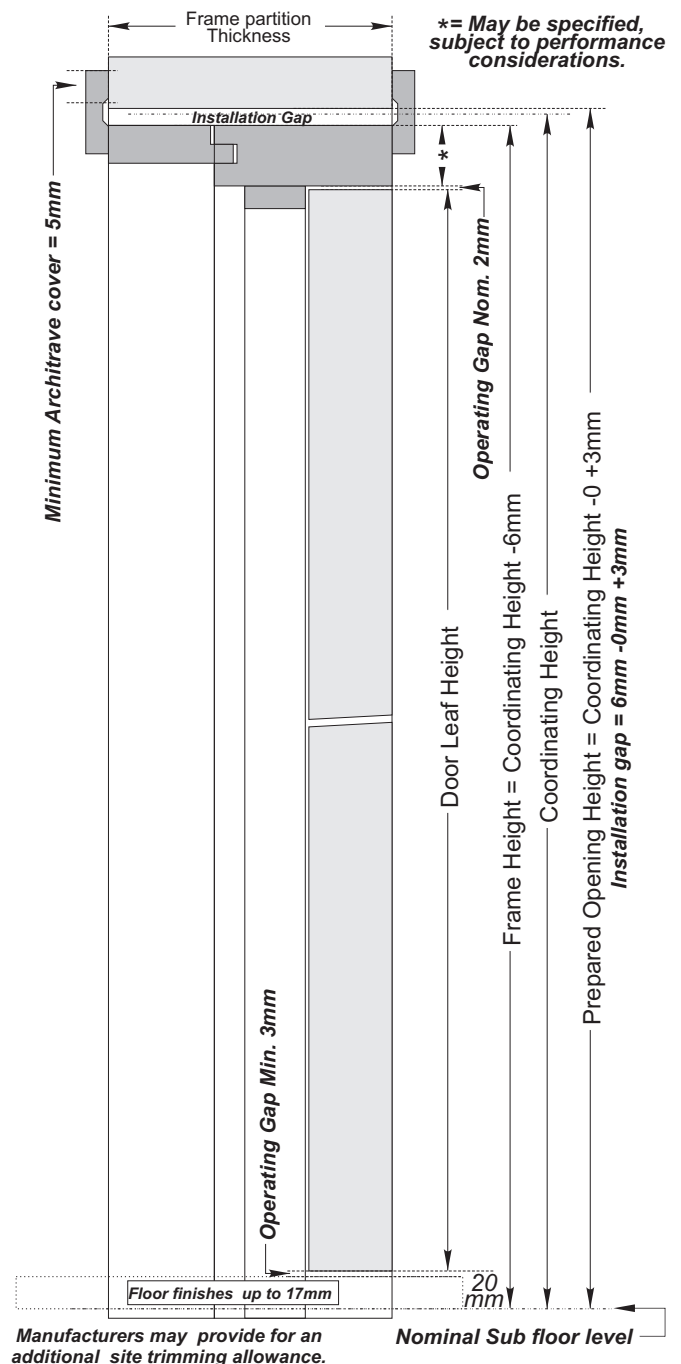

**NOTE:** The installation tolerance can be increased for frame designs using separate architrave subject to a minimum architrave cover of 5mm over the surrounding structure



**Storey Height Doorset - Single Action**  
**- Transomed Over panel OR Glazed Fanlight** Fig. 9.12

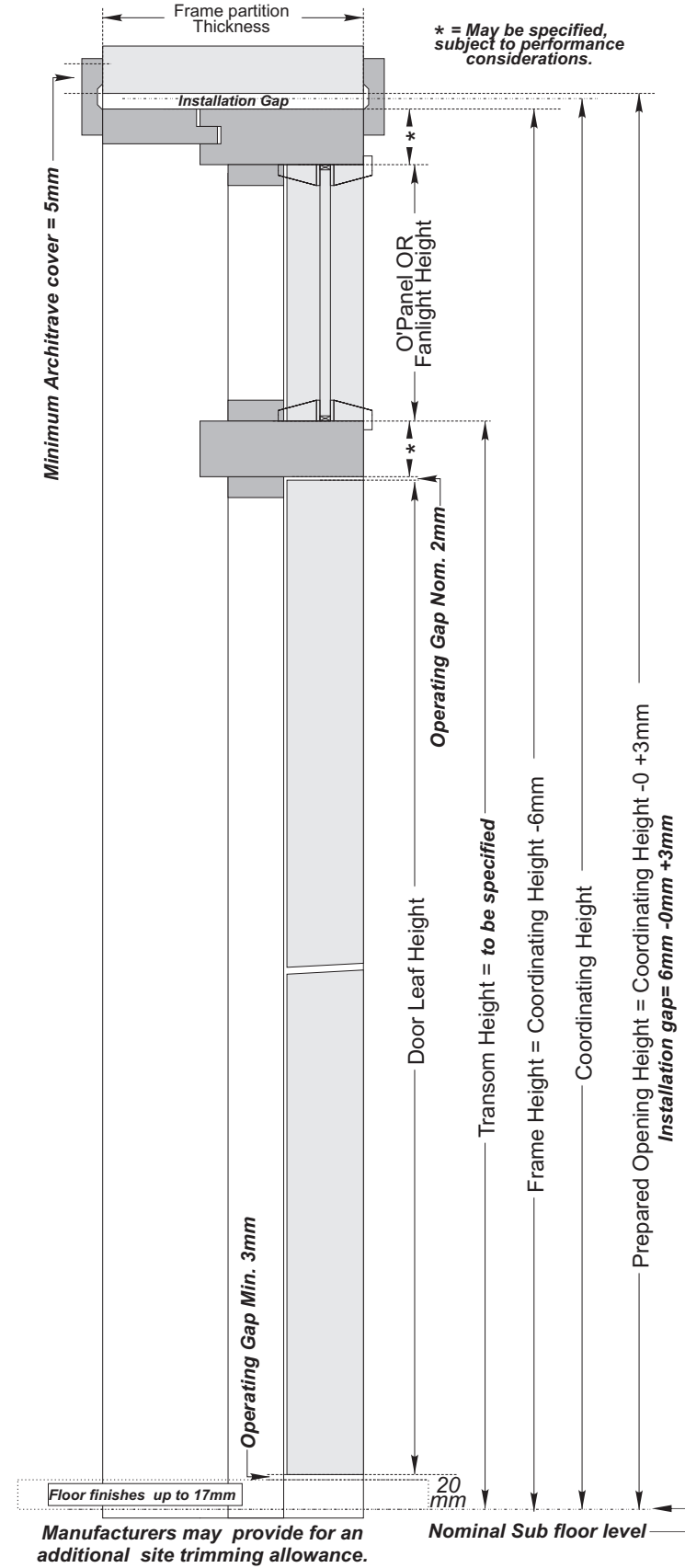

**Storey Height Doorsets - Single Action - with Transomed Over panel OR Fanlight**

For storey height doorsets with transom rails the frame height is calculated in the same manner as for door height doorsets.

Additional instructions are required for the purpose of locating the transom rail height.

Where transomed storey height doorsets are used with door height doorsets on the same project, the transom rail height will generally be set to align with the frame head position for door height doorsets in the absence of any other instructions.

**NOTE:** The Fanlight beading profile shown in this detail is indicative only to illustrate location.

Manufacturers may provide for an additional site trimming allowance.



**Storey Height Doorset - Single Action  
- Single Leaf - Flush Over panel**

*Fig. 9.13*

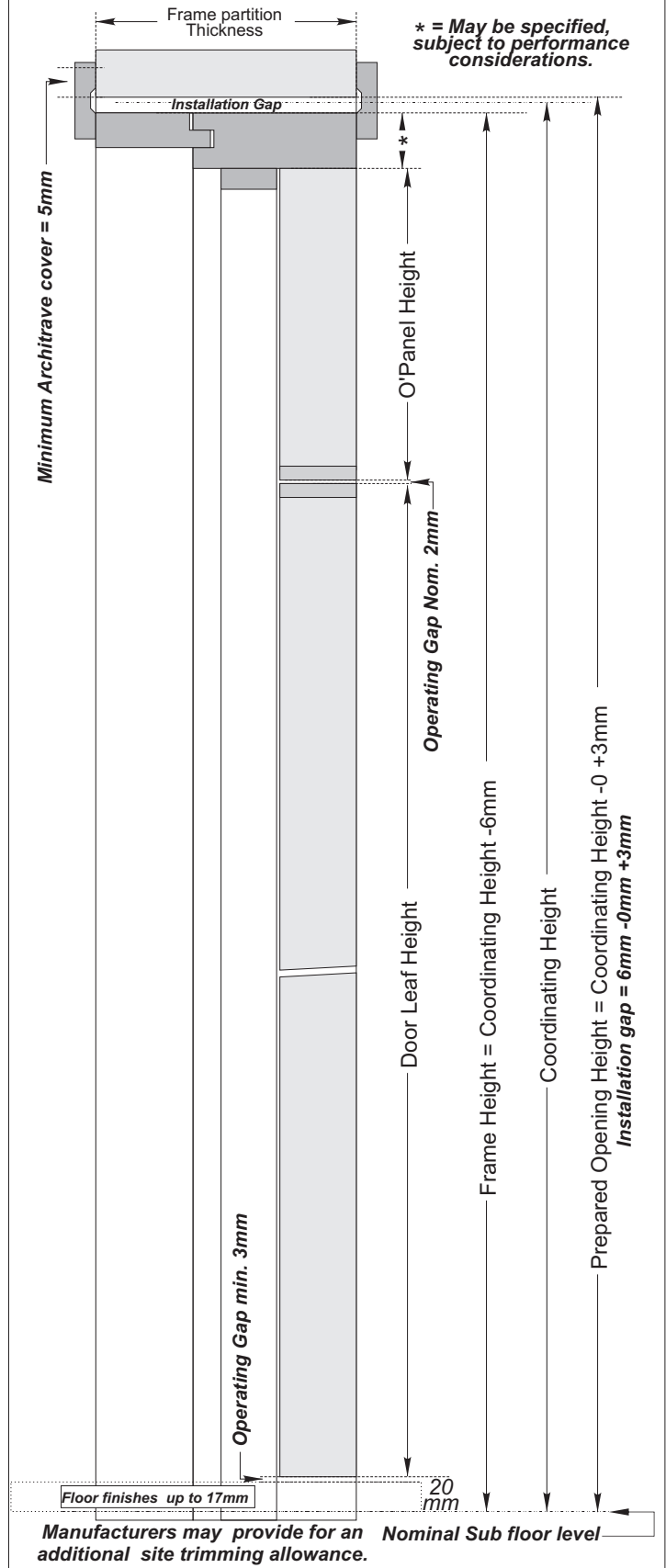

**Storey Height Doorsets - Single Action - with  
Flush Over panel - Single leaf doorsets.**

For storey height doorsets with flush over panels the door leaf height will be sized to suit door height doorsets that are specified for the same project.

Alternatively, the door leaf height should be specified by the Designer on a project basis.

**NOTE: Unless otherwise specified (and detailed) the overpanel widths will be to the full clear opening width of the frame i.e. door leaf width plus operating gap dimensions. Similarly, the overpanel will fit tight against the frame head unless otherwise specified (and detailed).**



**Storey Height Doorset - Single Action - Double Leaf (Pairs) - Flush Over panel** Fig. 9.14

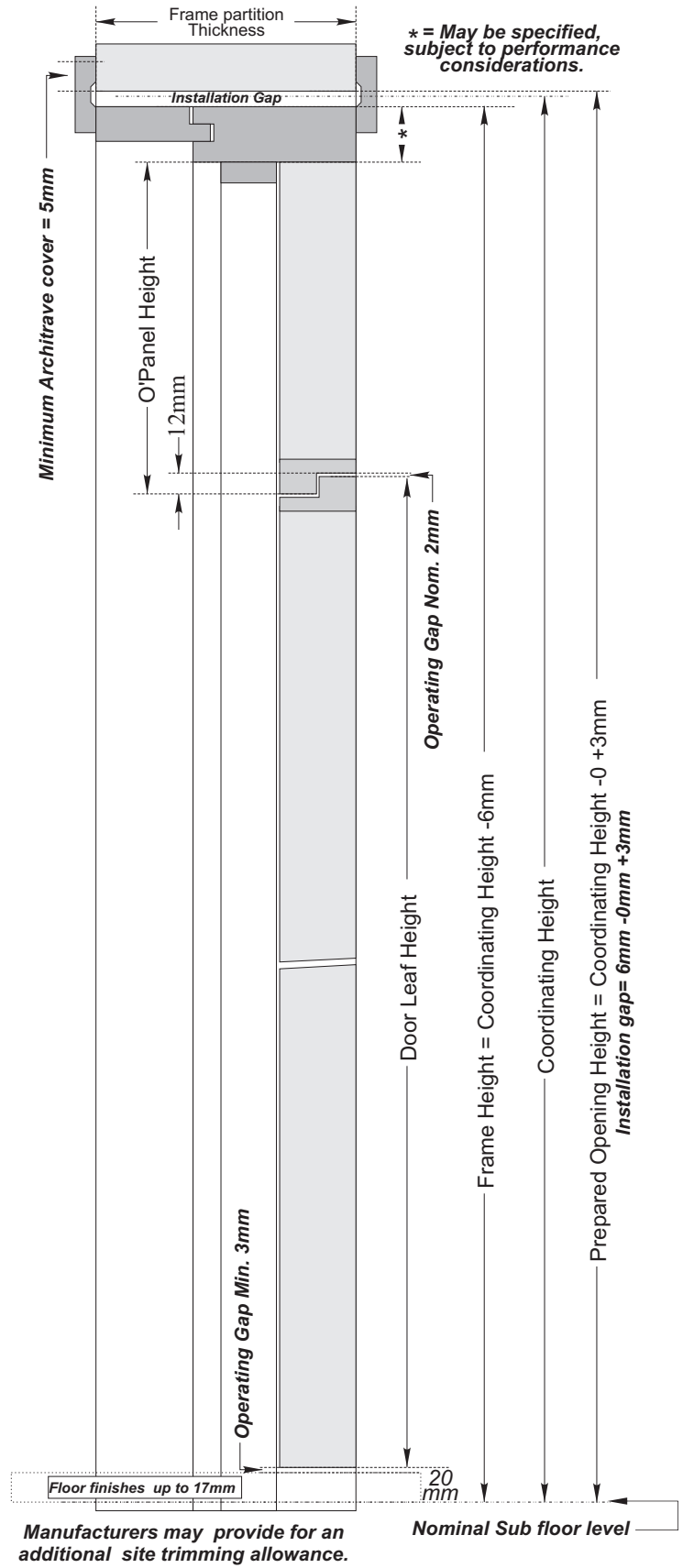

**Storey Height Doorsets - Single Action - with Flush Over panels - Double Door Doorsets (Pairs).**

For pairs of doors, a doorstop is required at the head of the door to prevent the doors from swinging through. Unless otherwise specified, this is generally achieved by rebating the door leaves to the over panel using a 12mm rebate.

Unless otherwise specified, the door leaf is sized such that the overall height of the door (including the rebate) is as specified or otherwise, the same as the door height for single leaf doorsets for the same project. The overpanel is sized to suit the remaining space between the top of the door and the underside of the frame head plus the 12mm rebate depth. i.e. both the door leaf and the over panel are dimensioned to show overall heights.

**NOTE:** To provide for some performance requirements and / or to suit some hardware fittings, the rebates at the top of the door and bottom of the overpanel may be off set in the thickness of the door.

**NOTE:** Unless otherwise specified (and detailed) the overpanel widths will be to the full clear opening width of the frame i.e. door leaf width plus operating gap dimensions. Similarly, the overpanel will fit tight against the frame head unless otherwise specified (and detailed).





### General Method - Doorset Coordination Doorset Widths - Double Action Doorsets:

- Generally the cover provided by the architrave allows for generous installation tolerances.
- The architrave, when fitted should provide for a minimum 5mm cover over the surrounding structure.
- The prepared opening width in the structure (**or the frame width**) should be calculated to provide for a minimum 6mm installation gap in width (*min. 3mm at each jamb*).
- Prepared openings must carefully formed and must be plumb and square to receive doorsets.

NOTE: Larger frame lining sections are required for some fire door applications .

NOTE: Some manufacturers may offer double action frame designs without a scallop or with a scallop depth that is at variance with this detail.

### Single Leaf Doorsets - Double Action

Fig. 9.15

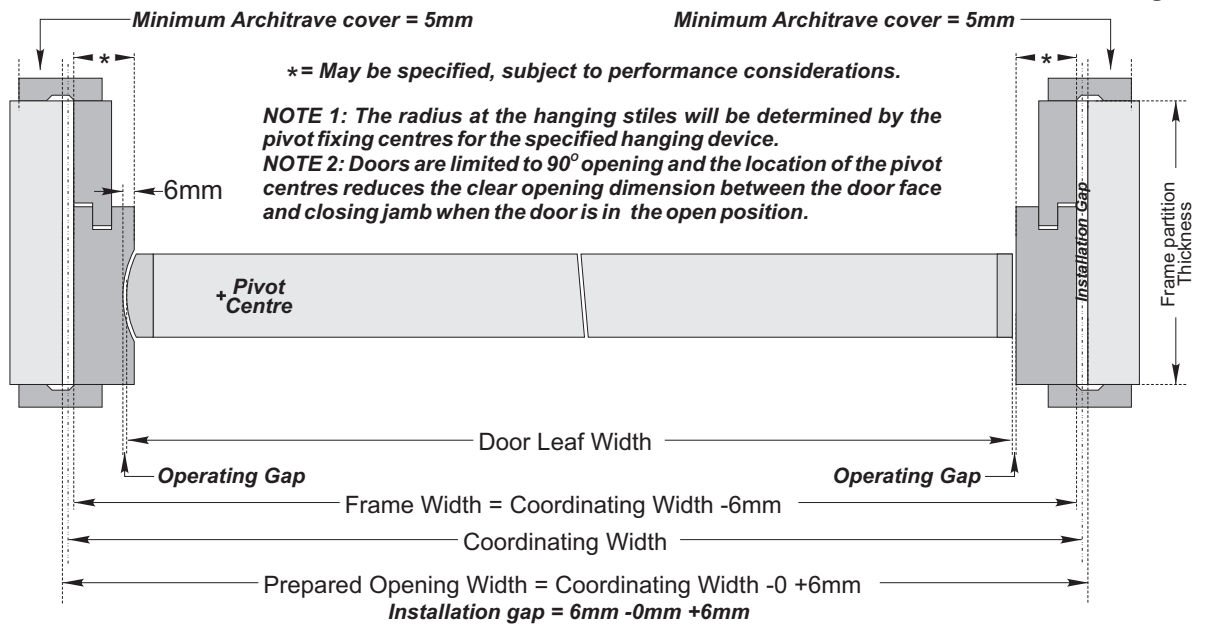

NOTE: The installation gap can be increased for frame designs using separate architrave subject to a minimum architrave cover of 5mm over the surrounding structure

### Double Leaf Doorsets (Pairs) - Double Action

Fig. 9.16

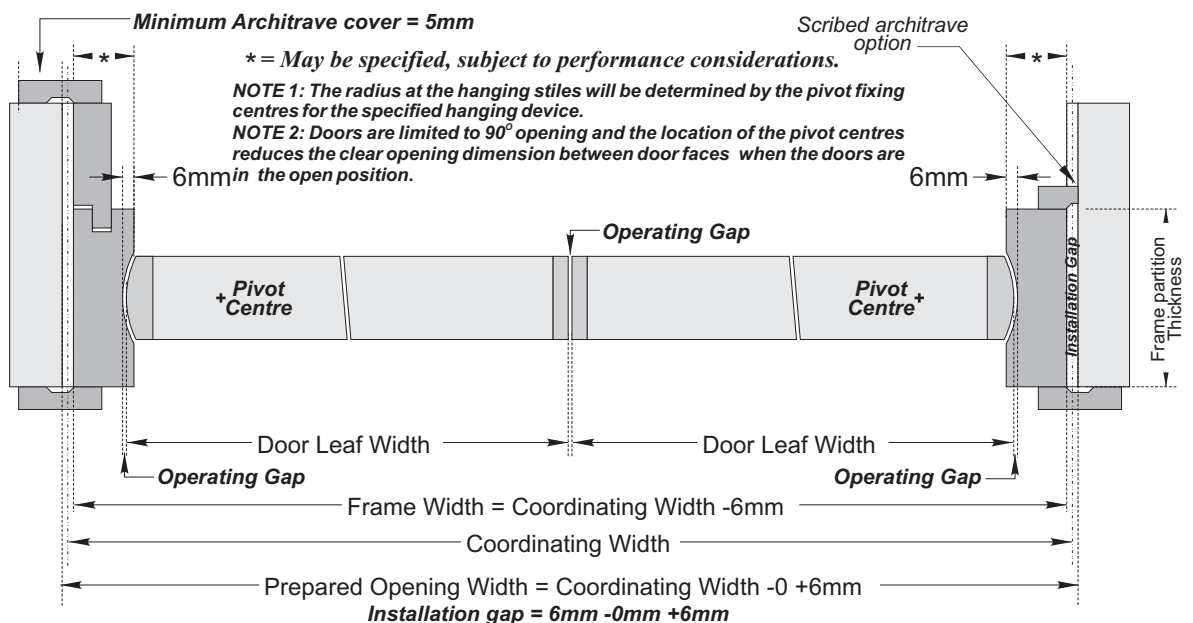

NOTE: The installation gap can be increased for frame designs using separate architrave subject to a minimum architrave cover of 5mm over the surrounding structure



**General Method - Doorset Coordination Doorset Widths - Double Action Doorsets: - Option 2:**

For some frame designs, or where required by the Designer, saddles are used to cover the joint between split frame components or to provide for a 'suited' appearance with single action doorsets. This will result in reduced door leaf widths for any given frame or coordinating width dimension.

**NOTE:** Some manufacturers may offer double action frame designs without a scallop or with a scallop depth that is at variance with this detail.

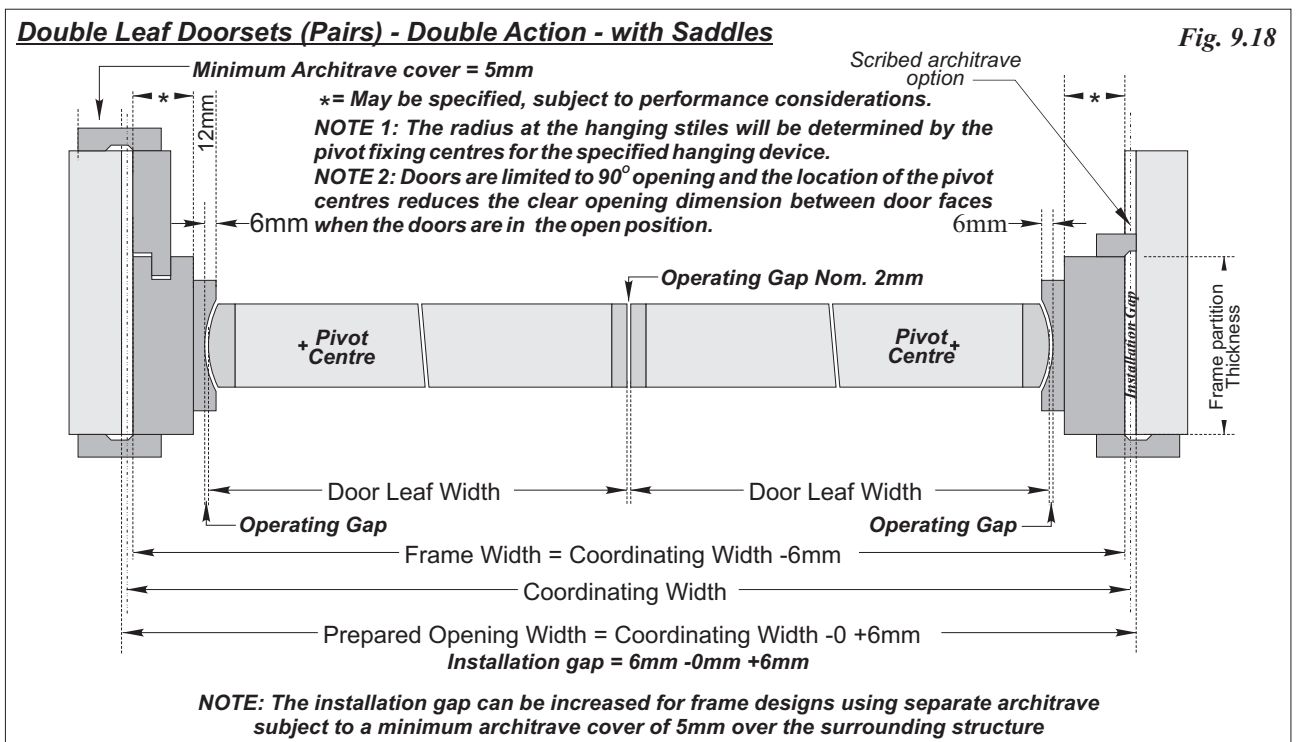
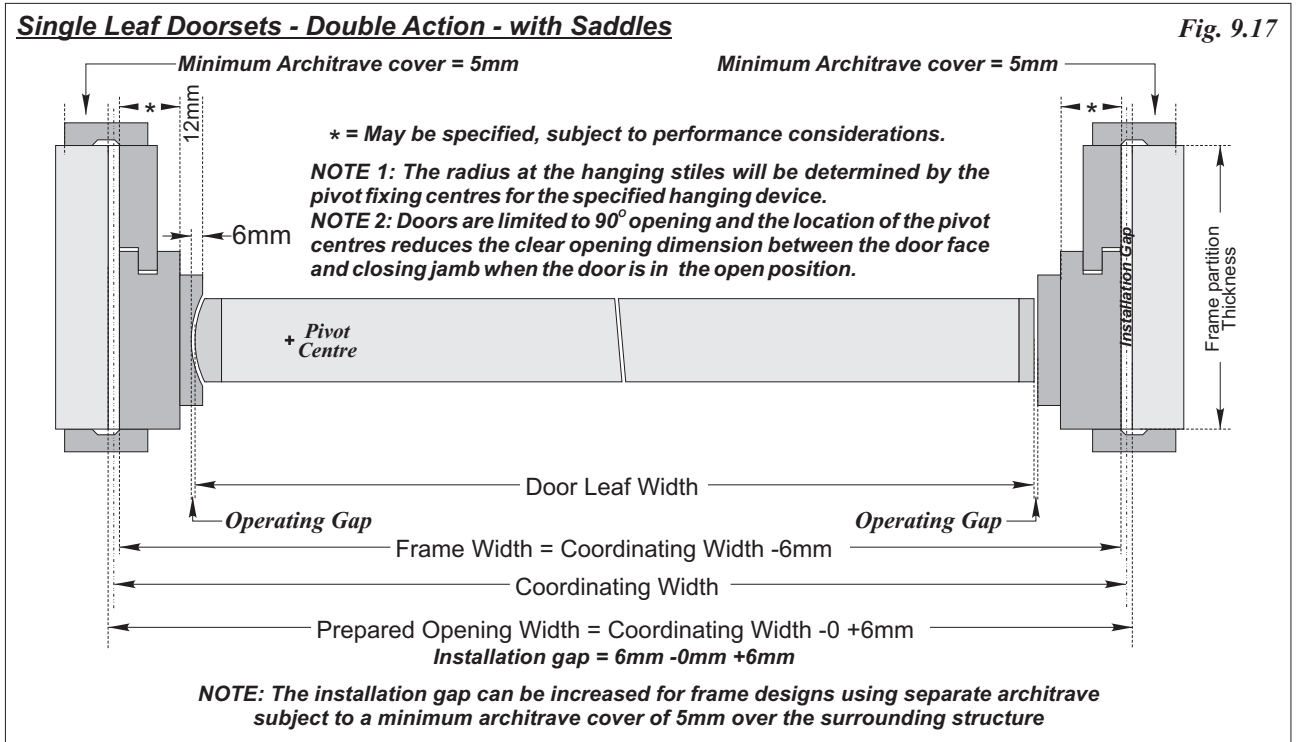



### General Method - Doorset Coordination Doorset Heights - Door Height Doorsets - Double Action:

This detail shows a typical arrangement for double action doors hung on floor mounted closers. Reference should be made to the particular closer details and fittings with the closer details to take precedence in the event of any conflict with the following advice.

To provide for the housing of the top pivot fixings it is recommended that the frame nose dimension at the frame head is increased relative to head sections for single action doorsets with a corresponding reduction in the door leaf height.

**NOTE:** It is possible to use a smaller head section. However, in this event the top pivot fixing may extend into the prepared opening space at the head of the frame. This is not recommended for doorsets in locations required to provide for fire rated or sound attenuating performances.

The particular closer details will give recommendations with regard to the clearance to be allowed from the top of the floor finish and the bottom of the double action strap fitting. With some closer designs the strap fittings can be recessed into the bottom edge of the door to provide for an under door gap between the bottom of the door and the top of the floor finish of not exceeding 3mm to the satisfaction of BS4787 Pt.1 and BS5588-11 or BS9999 : 2008 (for smoke sealed doorsets without additional threshold sealing). In this case the dimension from the top of the floor finish to the underside of the strap fitting is generally in the region of 8mm and it may be necessary to notch the heel of the door to aid installation.

The floor mounted closer manufacturer will usually offer a range of spindle lengths to suit variations in floor finishes such that the floor mounted closer box can be installed relative to the 'sub floor' level (before the application of floor finishes).

As with single action doorsets, frame jambs can be reduced by up to 17mm (plus any manufacturers additional trimming allowance) on site to suit actual floor finishes.

**IMPORTANT:** For both single action and double action doorsets where doors are hung using floor mounted closers in conjunction with raised floor designs, floor structure planning should provide for the secure installation of the floor mounted closer boxes.

### Door Height Doorset - Double Action

Fig. 9.19

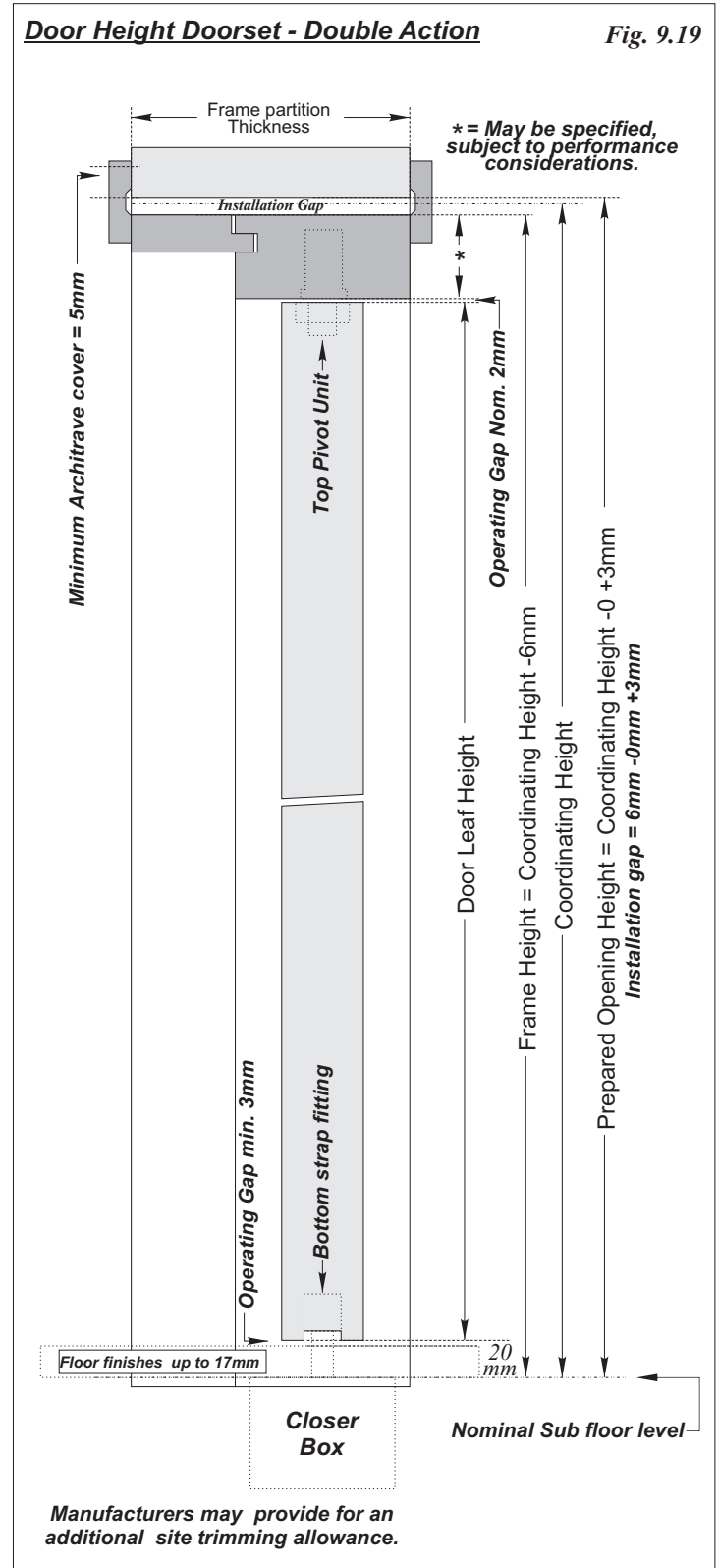



**Storey Height Doorset - Double Action - Transomed Over panel OR Glazed Fanlight Option 1** Fig. 9.20

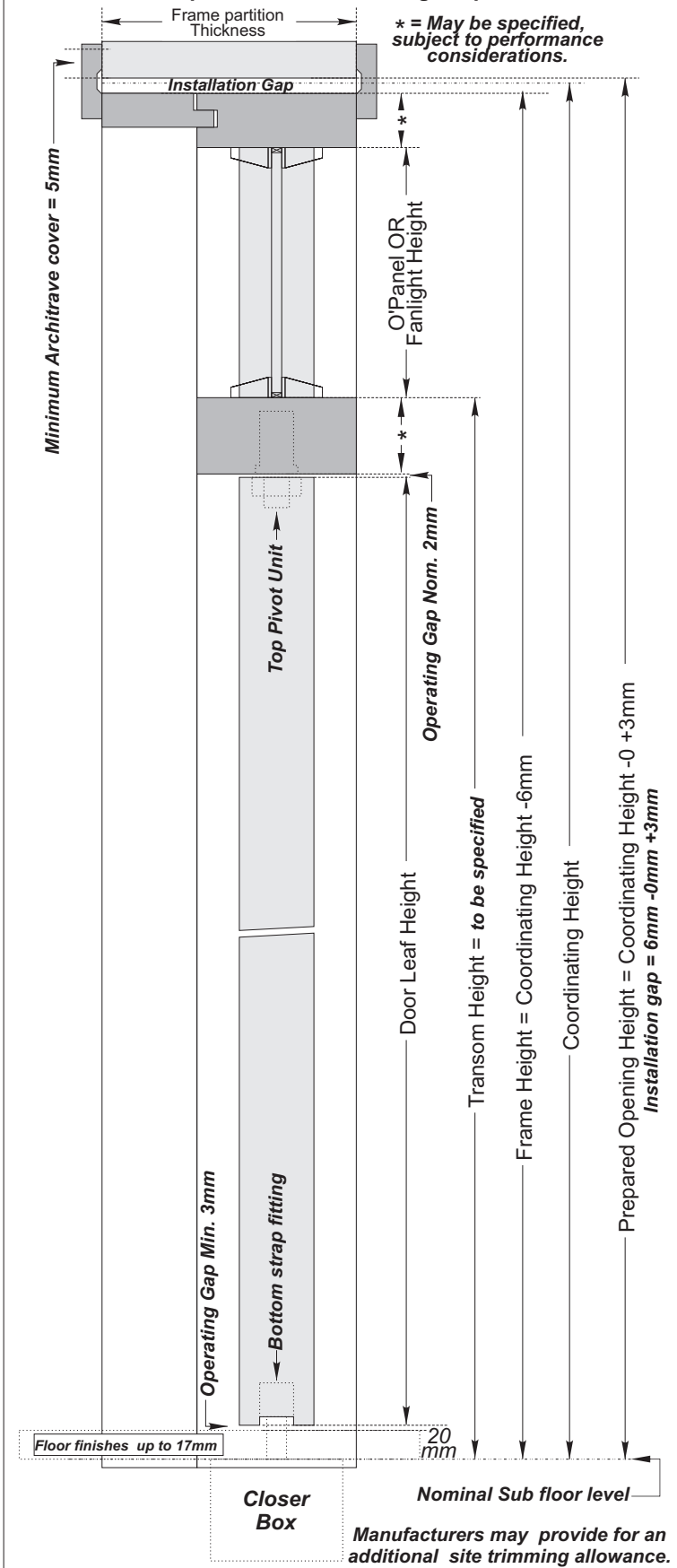

**Storey Height Doorsets - Double Action - with Transomed Over panel OR Fanlight Option 1**

For double action storey height doorsets with transom rails the frame height is calculated in the same manner as for door height doorsets.

Additional instructions are required for the purpose of locating the transom rail height.

It is recommended that the transom rail dimension is increased with a corresponding reduction in the door leaf height to provide for the housing of the top pivot fixings

**NOTE:** Unless otherwise specified (and detailed) the over panel widths will be to the full clear opening width of the frame i.e. door leaf width plus operating gap dimensions. Similarly, the over panel will fit tight against the frame head and transom unless otherwise specified (and detailed). The scallop in the frame will be stopped at the top of the door leaf to the underside of the transom. Where saddles are used the saddle will stop at the underside of the transom rail.

**NOTE:** Unless otherwise specified, the transom rail will be located at a position to align with the head of other door height double action doorsets for the same project.

**NOTE:** The Fanlight beading profile shown in this detail is indicative only to illustrate location.

**IMPORTANT:** For both single action and double action doorsets where doors are hung using floor mounted closers in conjunction with raised floor designs, floor structure planning should provide for the secure installation of the floor mounted closer boxes.



### Storey Height Doorset - Double Action - Flush Over panel

Fig. 9.21

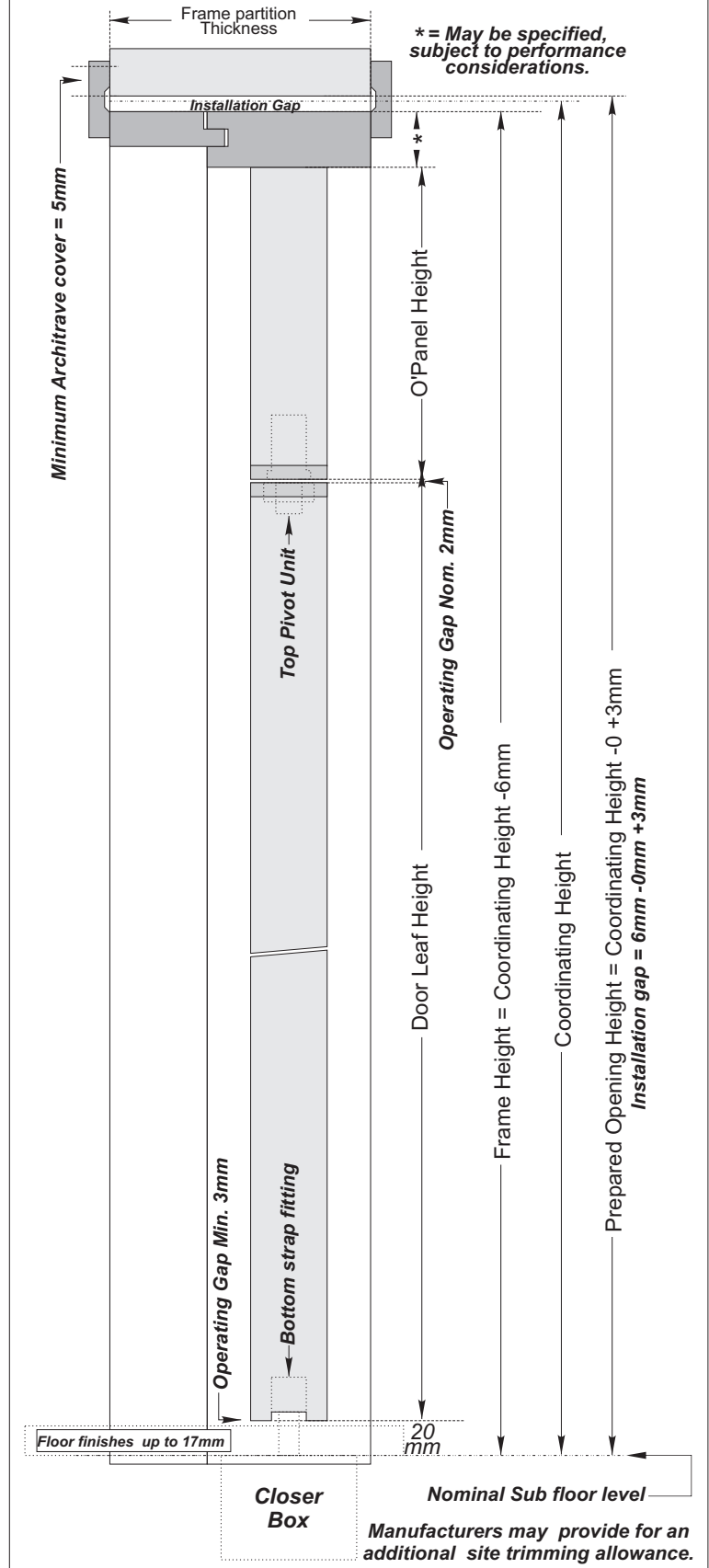

### Storey Height Doorsets - Double Action - with Flush Over panel - Single leaf doorsets.

For storey height doorsets with flush over panels the door leaf height will be sized to suit door height doorsets that are specified for the same project.

Alternatively, the door leaf height should be specified by the Designer on a project basis.

**NOTE:** Unless otherwise specified (and detailed) the over panel widths will be to the full clear opening width of the frame i.e. door leaf width plus operating tolerance dimensions. Similarly, the over panel will fit tight against the frame head unless otherwise specified (and detailed). The scallop in the frame will be stopped at the door leaf height to the underside of the over panel. This detail is not recommended for use with frame designs using saddles.

**IMPORTANT:** For both single action and double action doorsets where doors are hung using floor mounted closers in conjunction with raised floor designs, floor structure planning should provide for the secure installation of the floor mounted closer boxes.

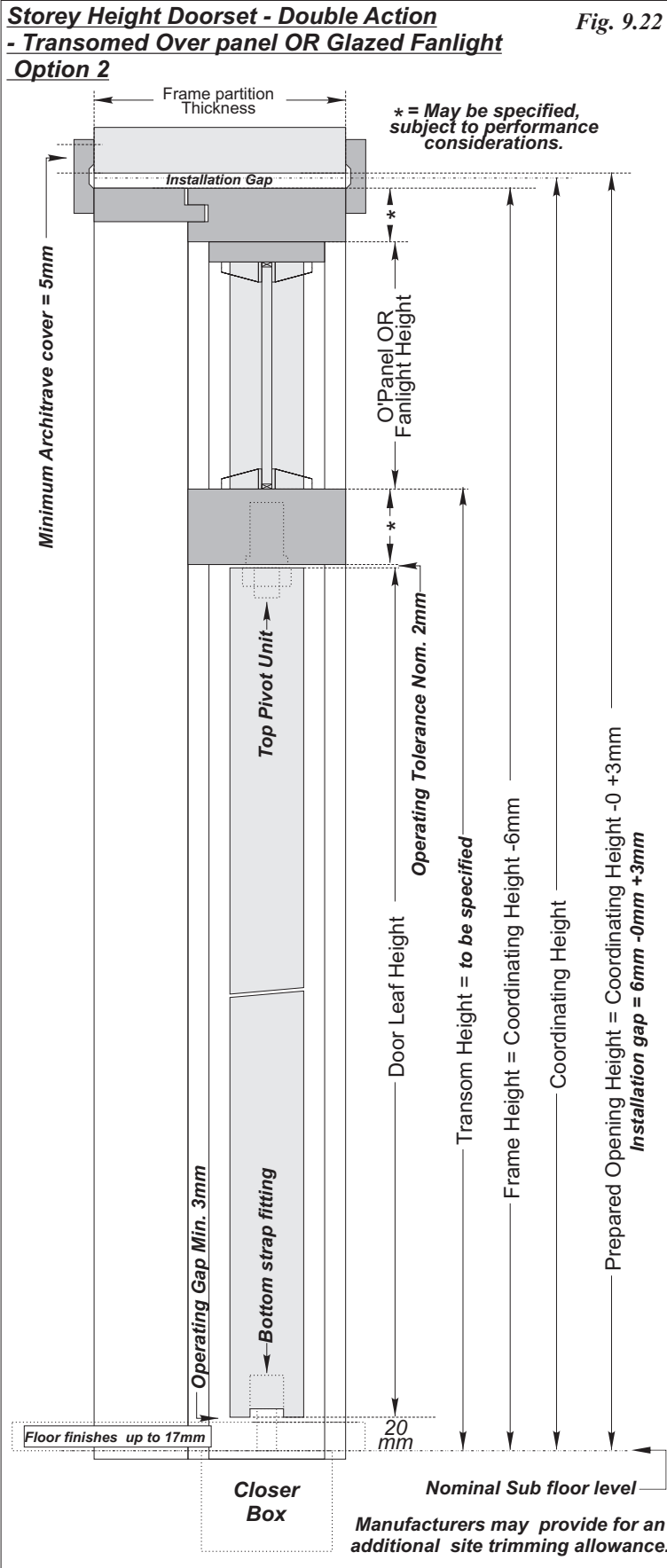

**Storey Height Doorsets - Double Action - with Transomed Over panel OR Fanlight. Option 2**

For frame designs using saddles, the saddles are applied to the jambs and head with saddles to butt to both sides of the transom rail. Square faced (**not scalloped**) saddles will be used at the over panel / glazed fanlight position.

**NOTE:** Unless otherwise specified, the transom rail will be located at a position to align with the head of other door height double action doorsets for the same project.

**NOTE:** The Fanlight beading profile shown in this detail is indicative only to illustrate location.

**IMPORTANT:** For both single action and double action doorsets where doors are hung using floor mounted closers in conjunction with raised floor designs, floor structure planning should provide for the secure installation of the floor mounted closer boxes.



### Increased Under Door Clearances:

Fig. 9.23

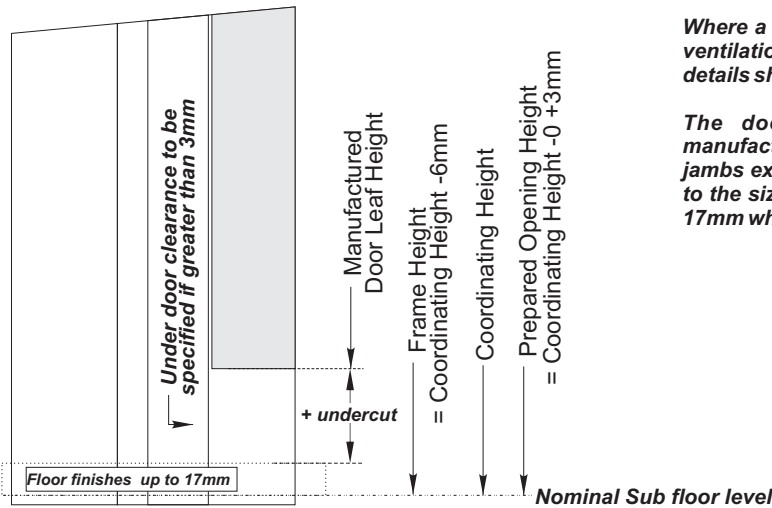

Manufacturers may provide for an additional site trimming allowance.

Where a large undercut is required e.g. for ventilation, the specifications / project details should identify this requirement.

The door manufacturer should then manufacture the doors such that the frame jambs extend below the bottom of the door to the size of the specified undercut + Min. 17mm when used with a 44mm architrave.

### Increased Door Undercut:

The general coordination method provides for frames to be manufactured such that the bottom of the frame jamb extends 20mm (**plus any additional trimming allowance made by the manufacturer**) below the bottom of the door leaf. This allows for site trimming to suit floor finishes up to 17mm thickness while still providing for a 3mm under door gap (**above finished floor level**) required to satisfy BS5588-11 or BS9999 : 2008 for smoke sealed doors without additional threshold seals.

The 'Sub Floor' level described in these details is the floor level before the application of floor finishes. Floor finishing materials can be many and varied including carpet with or without underlay, ceramic tiles, vinyl tiles etc. Where the floor finishing materials are less than 17mm this method provides for frame jambs to be reduced on site to suit.

For ceramic tiled areas the tiles can be laid before the doorset is installed. In other cases e.g. for carpeted areas the frames are generally fitted to suit the sub floor level before the flooring is laid.

Where the 17mm floor finish allowance provided for by these details is insufficient OR, where an increased under door clearance over the finished floor level is required (**e.g. for ventilation**), door leaves can be manufactured to a reduced height to suit the under door clearance requirements specified in project documents with a corresponding increase in the 20mm (**plus the additional site trimming allowance**) dimension from the bottom of the door to the bottom of the frame jambs allowed for the purpose of manufacture. Alternatively, door leaves may be reduced in height on site where minor adjustments are required.

Where these considerations apply, it is recommended that the Designer should ensure that the project details identify the requirement. The manufacturer will then add the door undercut dimension to the 'standard' dimension allowed from the bottom of the door to the bottom of the frame jamb.

**Example: If a 50mm undercut is required to provide for (say) ventilation. This is 47mm greater than the minimum 3mm allowance normally provided for. The door leaf height would be reduced by 47mm and the dimension from the bottom of the door to the bottom of the frame jambs would be increased from 20mm to 67mm plus any additional trimming allowance provided by the manufacturer to provide for the same degree of site adjustment. To define this example requirement project details should advise: Door undercut = 50mm.**



Fig. 9.24

**General Method - Frame Height Adjustment to suit Finished Floor levels - (44mm Architrave):**

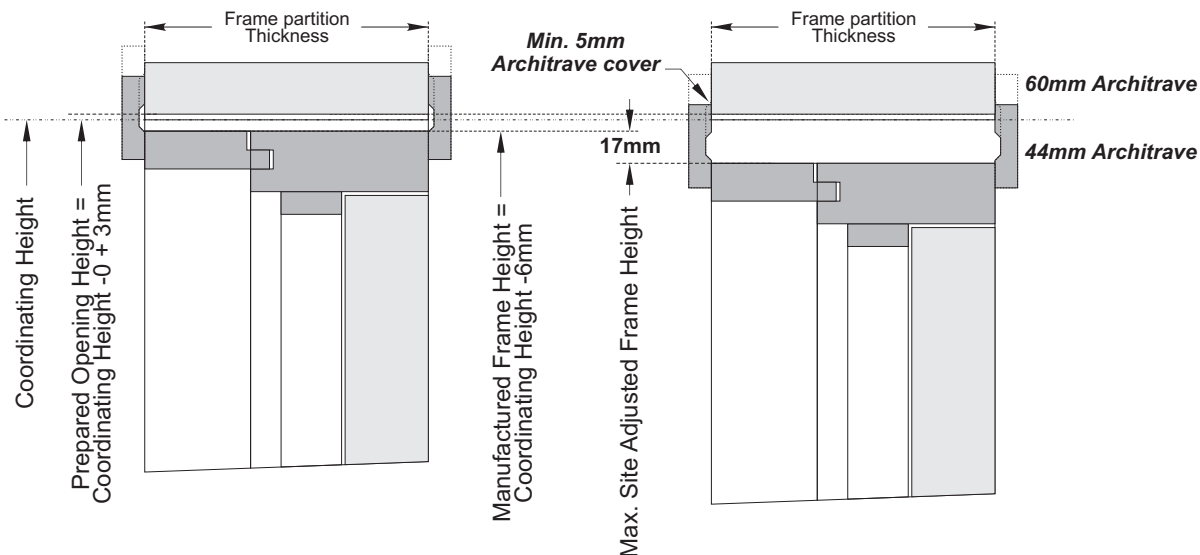

**General Method - Frame Height Adjustment:**

The general method suggested in this section provides for the frame jambs to extend 20mm below the bottom of the door leaf (*plus the any additional trimming allowance provided by the manufacturer*).

This provision will allow for the use of floor finishes up to 17mm thickness when used with a 44mm architrave.

**NOTE:** Increased scope for site adjustment and accommodation of increased installation gap tolerances can be provided where an architrave section greater than 44mm is used See Fig. 9.24.

When used with a 44mm architrave: If a floor finish is not used, or where the floor finish is less than 17mm, the frame jambs can be reduced on site to provide for the desired under door clearance over the actual floor finish where the maximum reduction to the frame jambs does not exceed 17mm (*plus any additional trimming allowance provided by the manufacturer*).

When used with a 44mm architrave: Where the maximum site reduction is carried out, this will provide for a Nom. 3mm under door clearance above the sub floor level but with an increase of up to 17mm in the space between the head of the frame and the opening prepared by the builder.

Where performance doorsets (*e.g. fire rated and sound attenuating doorsets*) are adjusted in this manner, additional packing is required at the head of the doorset. (See Section 14 - Fire Door Installation).

**NOTE:** The structural floor level may be treated as the sub floor level where a sub floor is not used. *e.g. possibly for car parks and some plant rooms.*

**Reduced Height - Performance Doorsets**

Fig. 9.25

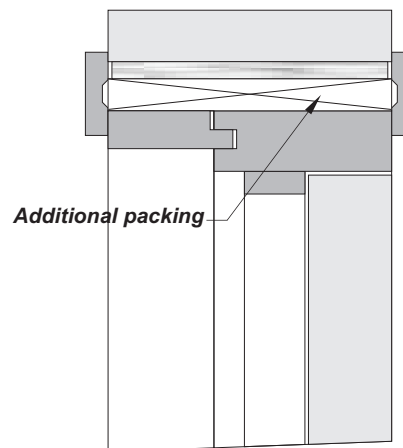

**For some performance doorsets e.g. fire rated and sound attenuating doorsets, additional packing is required at the head of the doorset where the doorset height is reduced to suit floor conditions.**

**Reference should be made to BS8214 : 2008 and to test / assessment data relating to the particular performance to determine requirements of this nature.**





### **Precision Method - Doorset Coordination:**

For the 'Precision Method' all trades concerned with the alignment in height of building products can work to a common DATUM. Trades that may be affected include:

- The Builder.
- Sub Floor Contractor.
- Floor finishing contractor.
- Electricians (*fitting switches etc.*)
- Doorset manufacturer.
- Installation Contractor.

For the purpose of manufacturing the doorset it is necessary to provide for more precise planning in advance of manufacture. Doorset considerations include:

- Door leaf height and width.
- Frame height, width and frame partition thickness.
- Required under door clearance above nominal finished floor level.
- Location dimensions and size of apertures.
- Location dimensions for hardware.

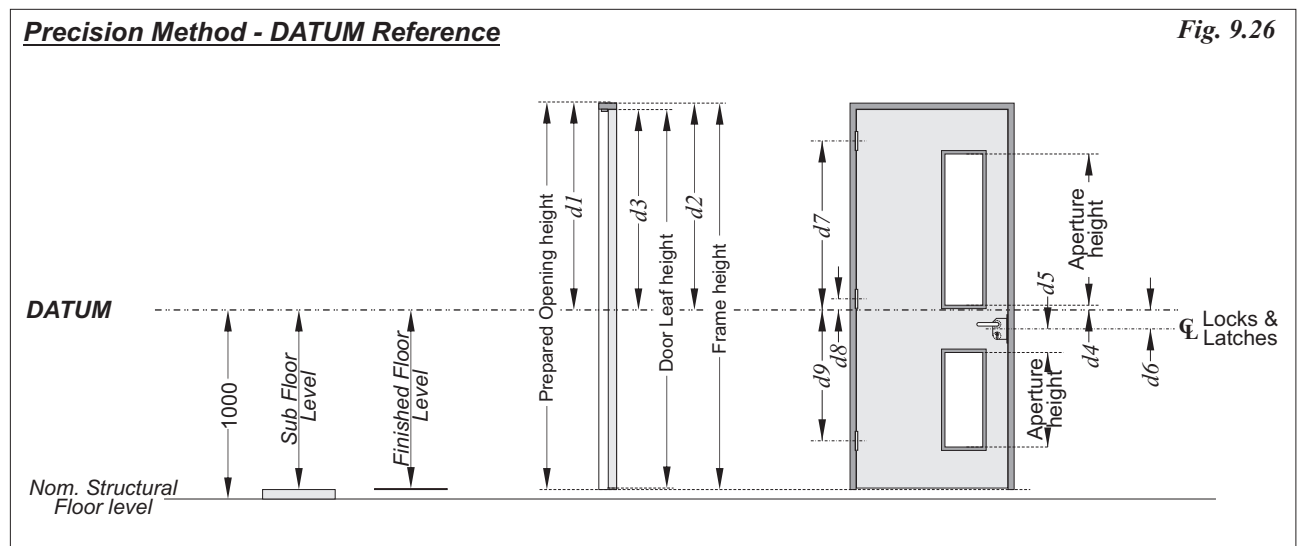

Using the Precision Method all work can be related to a common Project *DATUM*. For this example a *DATUM* height of 1000mm is indicated.

- The top of the sub floor level is located relative to the *DATUM*.
- The top of the finished floor level is located relative to the *DATUM*.
- Dimension **d1** - The opening is prepared by the Builder to receive the doorsets. Tolerance = -0 + 3mm.
- Dimension **d2** - Determine the Frame Height by use of dimension **d2**.
- Dimension **d3** - Determine position at the top of the door leaf by use of dimension **d3**. Calculate door leaf height by deducting frame nose dimension, operating tolerances (*including required under door clearance*) and finished floor thickness from the frame dimension.
- Dimension **d4** & **d5** - Locate apertures relative to the *DATUM* then define clear glass opening height.

**NOTE:** *Glazed apertures are positioned relative to the clear glass opening to ensure compliance with BS8300 - Building Regulations - (England & Wales) - Approved Document 'M'.*

- Dimension **d6** - Locate locks / latches relative to the *DATUM*.

**NOTE:** *This detail shows the dimension from the DATUM to the centre of the lock case. Alternatively separate references may be used to align (say) lever sets and cylinders.*

- Dimensions **d7**, **d8** & **d9** - align hinges relative to the *DATUM*.

Use of this method will ensure that doorset elements for adjacent doorsets will align correctly in height irrespective of the doorset height and floor conditions.



**Precision Method - Door Height Doorset - Single Action** Fig. 9.27

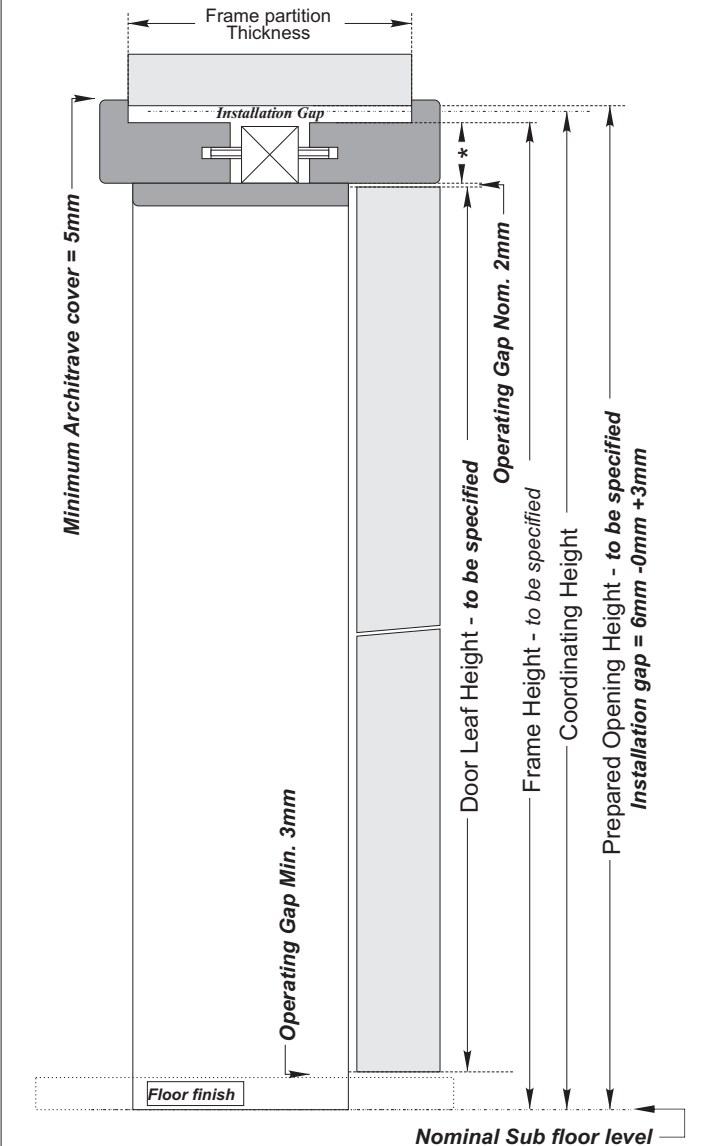

**Precision Method - Doorset Coordination Doorset Heights - Door Height Doorsets - Single Action:**

Coordinating doorsets in height is more difficult due to the number of trades involved. The Precision Method described in this detail is recommended for use with doorsets designs that provide for limited architrave cover or where the frame design otherwise restricts installation tolerances.

The Precision Method is also suitable where there is a requirement to provide for the precise alignment of doorset elements between adjacent doorsets.

This method provides for the supply of doorset with doorset elements cut to size and prepared to suit dimensions determined by the Architect / Designer.

Doorset components (*i.e. door leaves and frames*) are manufactured to the dimensions determined by the Architect / Designer with no provision for on site adjustment unless this has been provided for by the Designer.

**Precision Method for the alignment of doorsets (Example):**

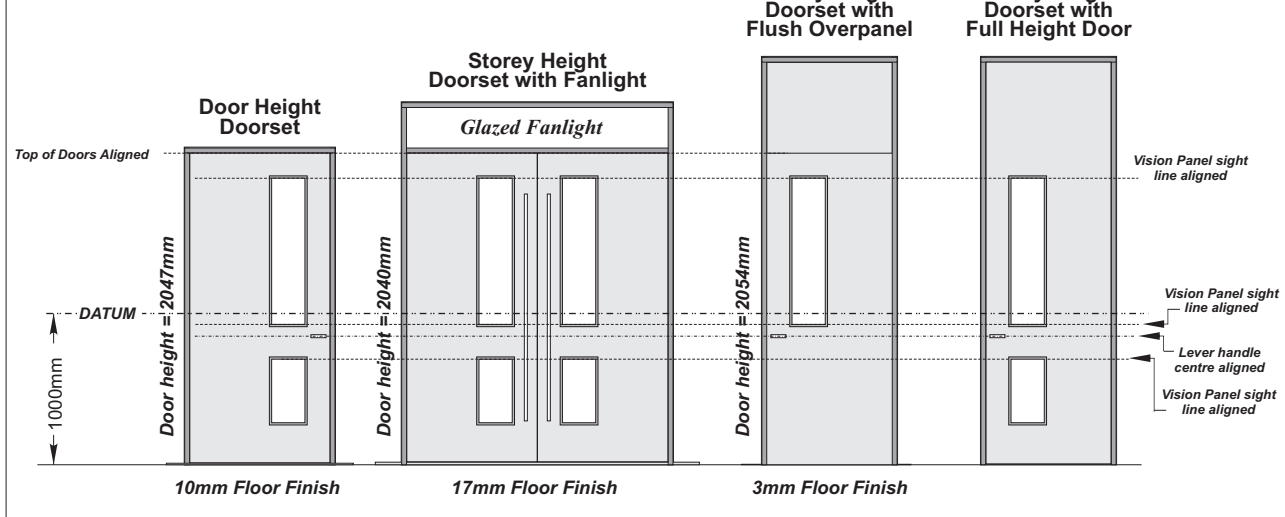

**Fig. 9.28**



### Door Frames:

Whereas it is possible to fit a door into an opening without the use of a frame, generally frames are used as a doorset component that links the door leaf with the surrounding structure.

Frames can be manufactured using a wide range of materials including:

- Hardwoods.
- Softwoods.
- MDF (**Medium Density Fibreboard**).
- Chipboard.
- Metal or metal clad.

Frames (**usually MDF or Chipboard**) can be manufactured with veneered facings and are also available with post formed laminate, high impact plastic or metal facings.

This Fig.9.29 illustrates height and width coordinating reference points for frames that may be used for the purpose of communicating dimensional requirements and subsequently for determining door leaf dimensions.

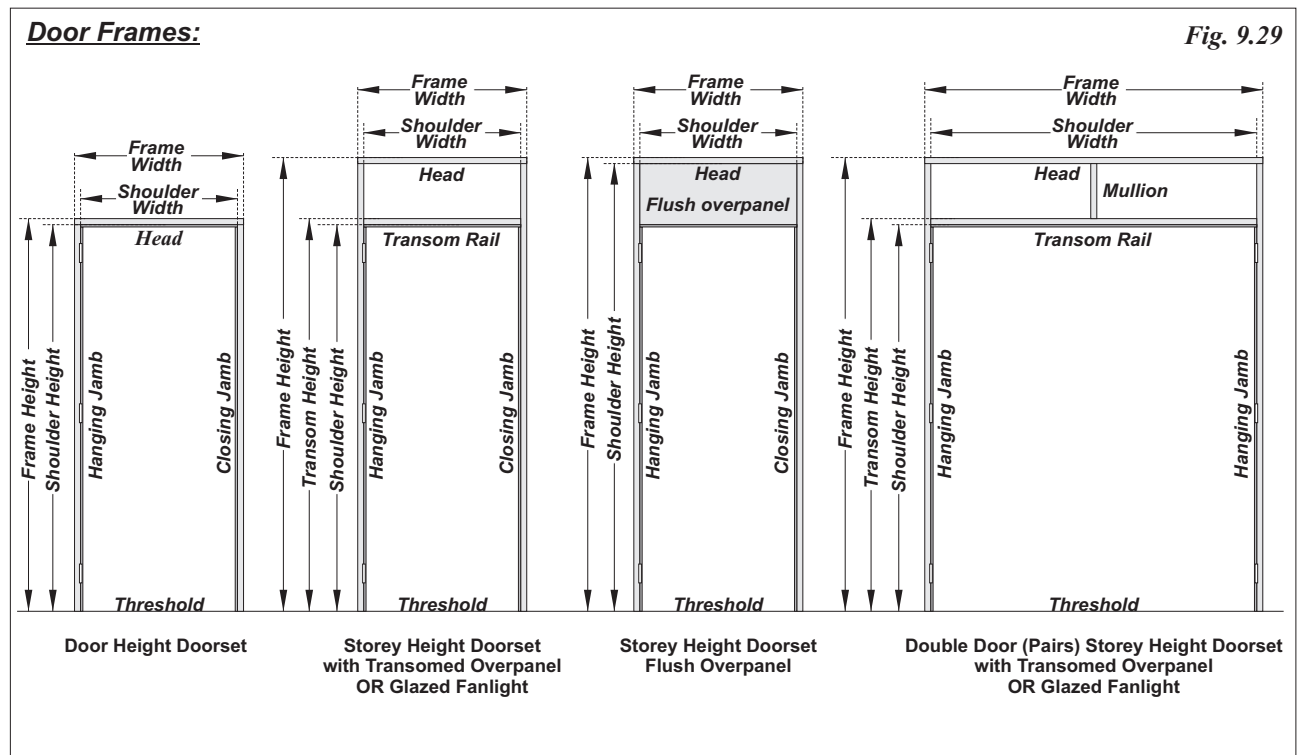



**Frame Designs suitable for the General Method of Coordination:**

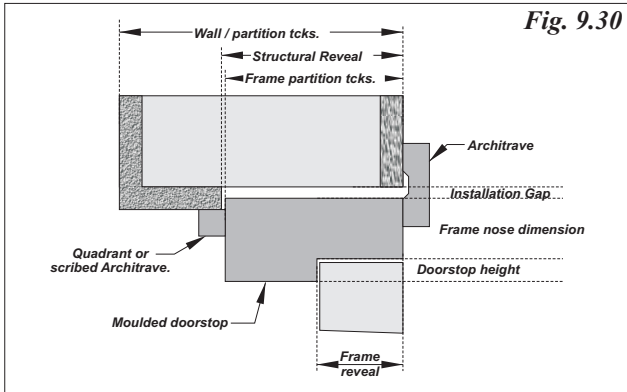

Fig. 9.30

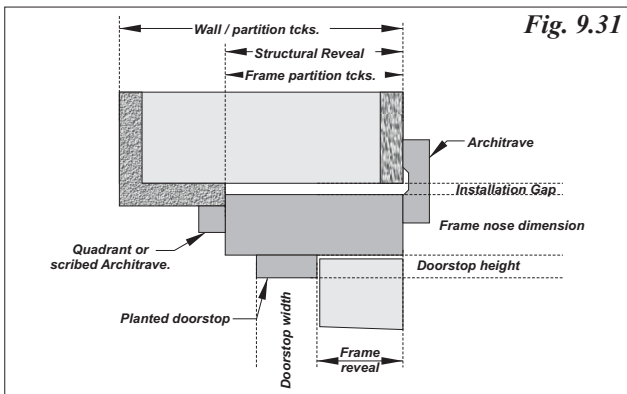

Fig. 9.31

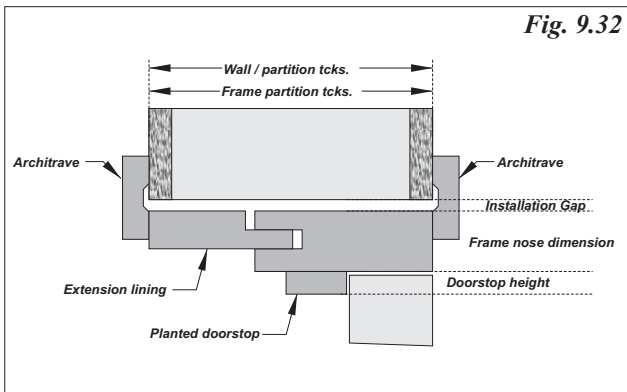

Fig. 9.32

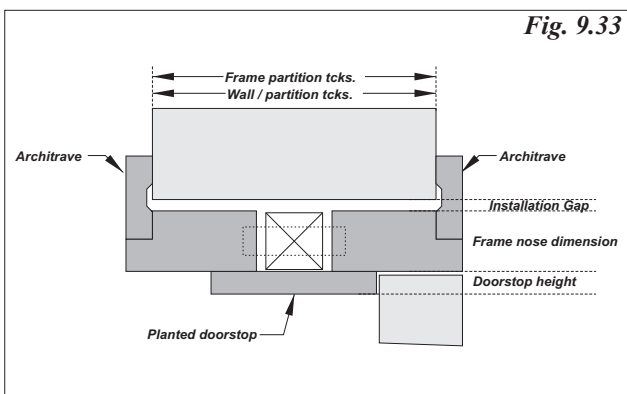

Fig. 9.33

**Frame Designs:**

Subject to performance limitations, frame designs may be determined by the Specifier. However, many bespoke doorset manufacturers have their own preferred frame systems that are designed (**and proven**) to provide for flexibility in use and for the economic use of timber.

**Moulded Stop designs:** The frame partition thickness can suit a structural reveal (**as illustrated**) or may extend to the full finished thickness of the partition. The doorstop is moulded from a solid section of timber to form a frame reveal. Where different facing materials are used on the door face it will be necessary either to calibrate the door core or to vary the frame reveal dimension to suit.

**Planted doorstop designs:** The doorstop is manufactured as a separate frame component allowing for variations in the doorstop height which may be necessary for some performance doorset applications and for the adjustment of the position of the doorstop to suit the particular door leaf thickness. The frame partition thickness can suit a structural reveal (**as illustrated**) or may extend to the full finished thickness of the partition.

**Frames with extension linings:** Extension linings of a thinner section than the primary frame section may be used to provide for cover of the structural reveal to the full wall / partition thickness. Designs of this type will generally provide for a means of adjustment (**around +/- 5mm**) to accommodate wall / partition thickness tolerances. The primary frame section may be of a moulded or planted stop design.

**NOTE:** Double action doors may be located to suit the primary (door related) frame section with doors offset within the partition thickness to provide for adequate fixings for double action fittings. Alternatively, the primary frame section can be located to suit the centre partition thickness with extension linings used to both sides of the primary frame section.

**Split Frame Designs with separate architrave:** Frame designs of this type use two frame sections with equal frame nose dimensions with the void between the frame sections covered by a variable door stop. The two frame sections may be jointed using dowels or plywood tongues. Make up pieces using low cost timber may also be used with frames of this design to suit large partition thicknesses.

**NOTE:** Double action doors may be located to suit the primary frame section with doors offset within the partition thickness to provide for adequate fixings for double action fittings.



**Frame Designs where use of the Precision Method of Coordination is recommended:**

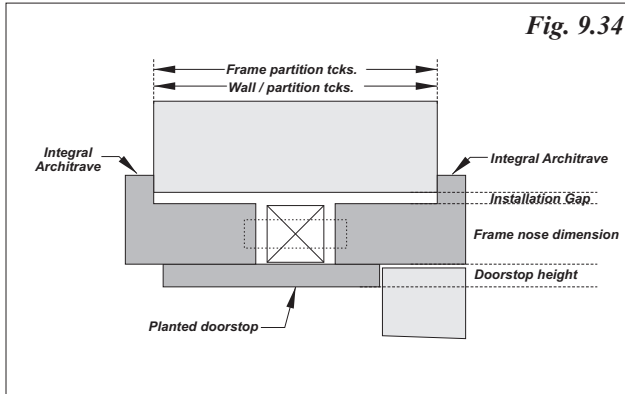

**Split Frame Designs with integral Architrave:** Projects requiring the use of frame designs that provide for limited or no architrave cover over the surrounding structure require demanding levels of care and skill in the planning, preparation and installation of the work to provide for satisfactory results. Use of the 'Precision Method' suggested in this document provides for one method for achieving expectations in this regard.

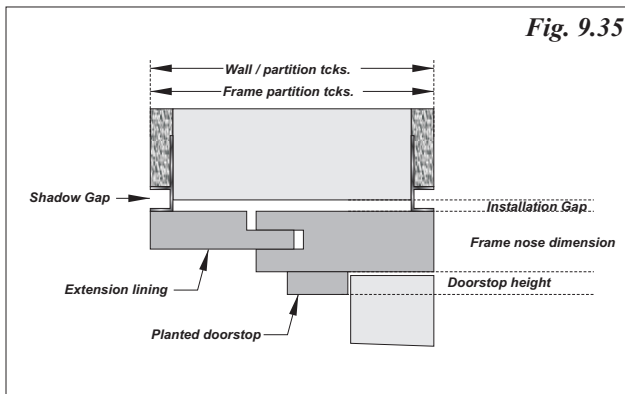

**Frame Designs without Architrave:** For frame designs using a 'shadow gap' the doorset should be installed before the application of the final wall / partitioning finishing with a dry lining option being recommended to minimise the risk of moisture or plaster contamination of the door frame.

**NOTE:** Use of frame designs with shadow gaps may not be suitable for some performance applications, (particularly fire performance). Reference should be made to the manufacturers test / assessment data to determine any limiting factors in this regard.

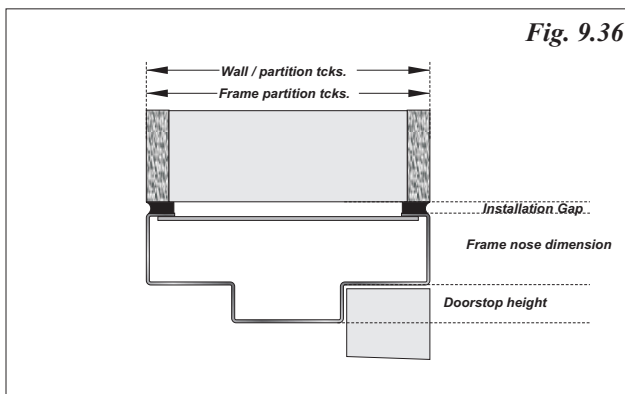

**Metal Frames:** Most metal frame, particularly steel frame designs do not include architrave. Considerations related to frame with 'shadow gaps' will generally apply.

Some metal frames need to be installed as 1st. fixed items and effectively become part of the structure. Other designs provide for 2nd. fix installation into prepared openings with shims used at the fixing positions. The gap between the frame and the surrounding structure being filled with a mastic. As with frames using a 'shadow gap' detail, high levels of skill, planning and installation are required to ensure even installation gaps around the doorset.

**NOTE 1:** It is difficult to adjust metal frames on site and site adjustment provisions are rarely allowed with doorsets of this design.

**NOTE 2:** Whereas there is successful test evidence supporting the use of wood doors with metal frames for fire door applications this is generally associated with reduced dimensional limitations. Reference should be made to the manufacturers fire test / assessment data to determine limiting factors relating to the use of metal frames, including a possible requirement to back fill frames.



**Variations to Frame Section Dimensions:**

Where frame section dimensions are varied either to satisfy aesthetic requirements or for performance reasons, the project Coordinating sizes and Prepared Opening dimensions can be maintained with the adjustments applied as follows:

Increased frame nose dimension: Reduce door leaf dimensions to suit.

Reduced frame nose dimension: Increase the installation gaps and provide for additional packing as required. (Alternatively, Frame width and height dimensions may be varied to suit with a corresponding adjustment to door leaf dimensions).

**Note 1:** These options are only available for use with frame designs using separate architrave that are suitable for the 'General Method' of doorset coordination.

**Note 2:** Reference should be made to BS8300 (Provisions for the disabled) and regulations concerning clear opening widths for escape purposes when reducing door leaf widths.

**Note 3:** When considering the use of thinner section frames, consideration should also be given to the screw holding capabilities (particularly with regard to the fixing of hanging devices) of the resultant frame section with due regard to the door leaf weight.

**Note 4:** Additional size architrave may be desirable for use with thinner section frames.

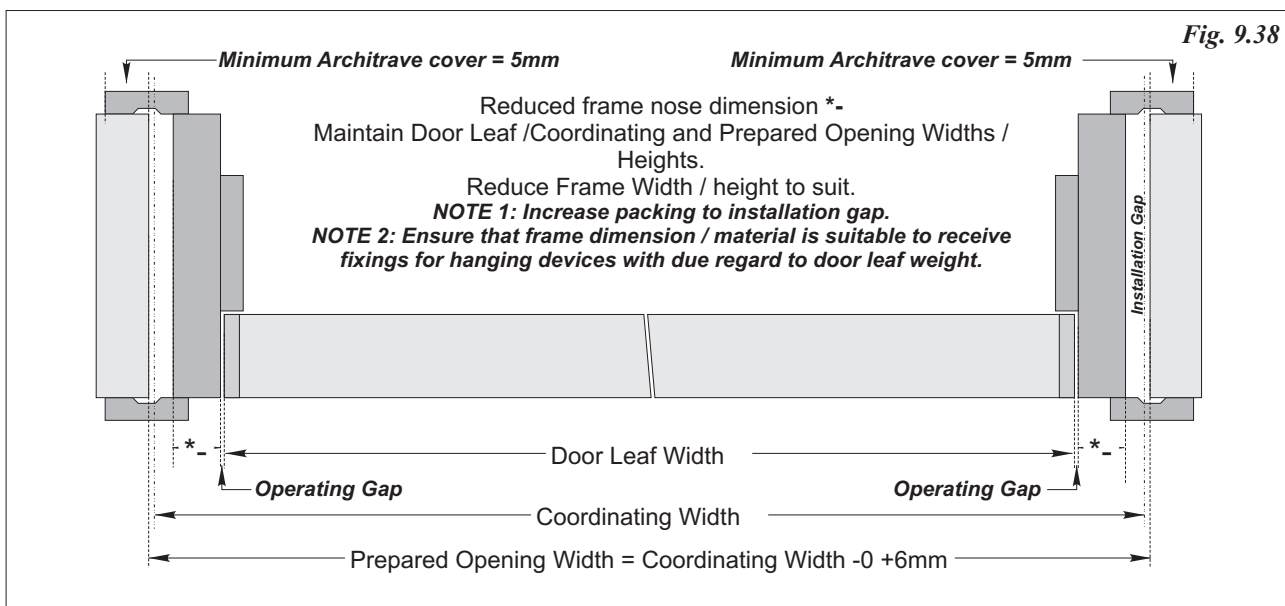
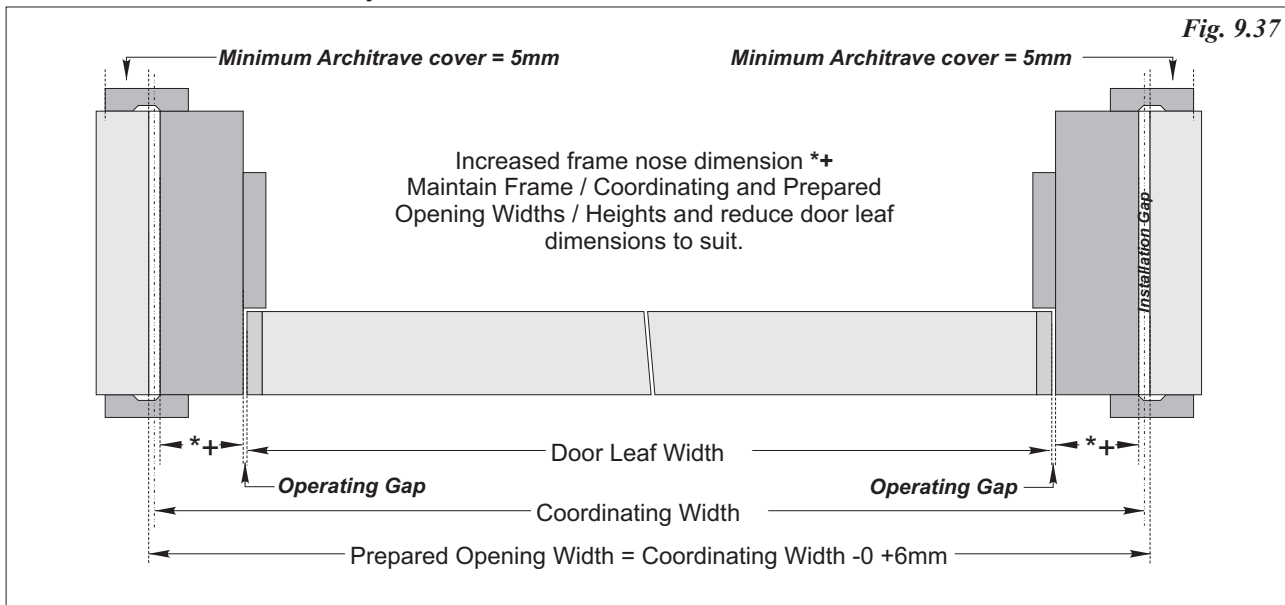



### Locating Apertures:

Whereas variations in door undercut might be relatively common, it is unusual to require an air space between the top of the door and the head of the frame. Where this is a requirement, precise details should be provided by the Designer.

As variations in undercut usually apply to the bottom edge of the door, most manufacturers will locate apertures in height relative to the top edge of the door leaf.

Information required by the manufacturer to locate apertures is shown in these details.

For the 'General Method' described in this document measurements are taken relative to the top edge of the door in height and the closing stile in width with two essential dimensions in each plane required:

1/ A reference dimension = **R1** & **R2** in this detail.

2/ An aperture dimension = **d1** & **d2** in this detail.

**NOTE:** For the 'Precision Method' apertures are location by reference to the project DATUM.

Primarily as a consequence of the influence of Building Regulation - (**England & Wales**) - Approved Document 'M' and the related BS8300, the dimensions related to glazed apertures will be assumed to refer to the clear glass dimensions (**the vision area after beading**), unless otherwise specified. Manufacturers will then cut the aperture in the door leaf to suit the beading dimension that may vary according to performance.

For apertures other than glazed apertures (**e.g. to receive grilles**), the apertures will be cut to suit specified dimensions.

**NOTE 1:** For rebated pairs of doors, the reference dimension to locate the aperture will generally be taken from the widest edge of the door unless otherwise specified in project details.

**NOTE 2:** Reference should be made to test / assessment data relating to the particular performance when considering glass type, beading system and the location of apertures in fire rated doorsets.

### General Method - Locating Apertures:

Fig. 9.39

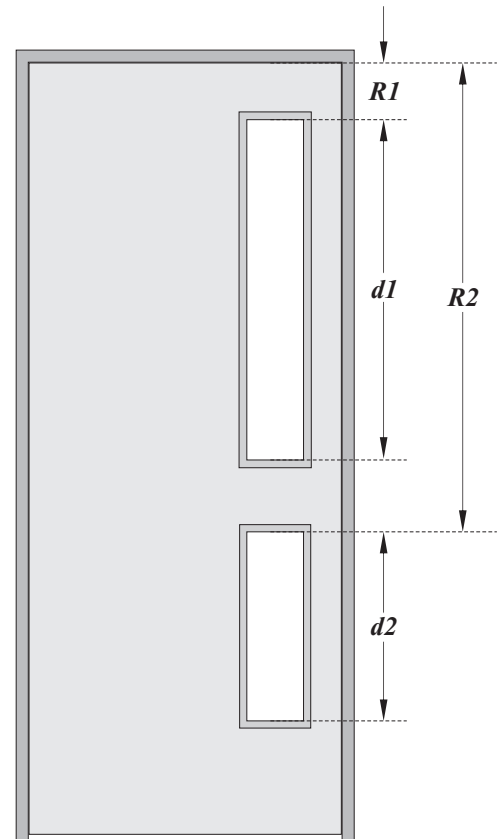

### Locating Apertures in Width:

Fig. 9.40

Determine the reference dimensions R1 relative to the closing stile of the door leaf.

#### Square edged doors:

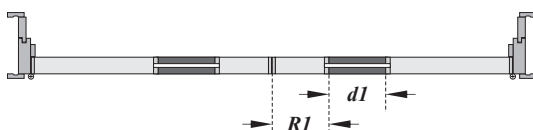

#### Doors with rebated meeting stiles:

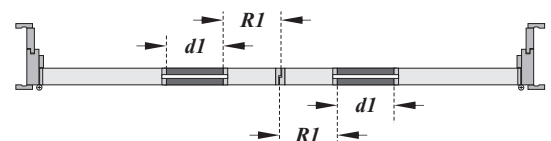



**General Method**  
**- Locating Hinges:**

*Fig. 9.41*

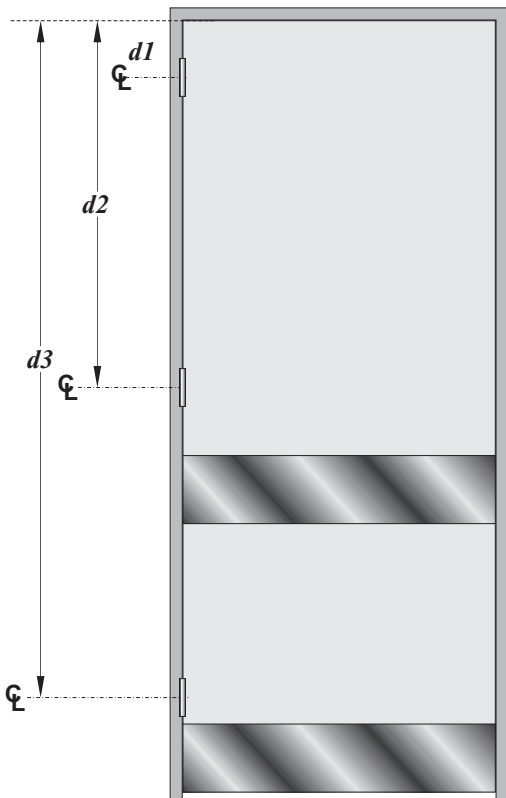

**Locating Hardware:**

**1/ Hinges:**

Whereas variations in door undercut might be quite common, it is unusual to require an air space between the top of the door and the head of the frame. Where this is a requirement, precise details should be provided by the Designer.

As variations in undercut usually apply to the bottom edge of the door, manufacturers will locate hardware relative to the top edge of the door leaf.

For the 'General Method' described in this document measurements are taken relative to the top edge of the door.

**NOTE:** For the 'Precision Method' hardware location is determined by reference to the project DATUM.

Requirements and restrictions relating to the location of hinges (*i.e. dimensions d1, d2 & d3 in these details*) may be found by reference to the hinge manufacturers technical data. Otherwise hinges may be located to suit Designers instructions.

For fire rated doors reference should be made to the fire test / assessment data relating to the particular performance which may place restrictions with regard to the hinge type and location and the need (*or otherwise*) for the use of intumescent gaskets under hinge blades. (See **BS 8214 : 2008**).

Consideration should be given to the location of other hardware when locating hinges, in particular conflict with metal protection plates (*kick & buffer plates*) should be avoided.





### Locating Hardware:

#### **2/ Locks & Latches (Securing devices):**

There are numerous designs of latches and locks, some of these use the same size case for different functions, for other designs the cases may vary according to function.

For most bespoke projects, Architects and Designers may be concerned with the visible elements i.e. lever handles and cylinders / escutcheons. Requirements (with dimensions) in this regard should be identified in project details.

For the 'General Method' described in this document it is recommended that securing hardware is located relative to the top edge of the door for the same reasons as stated for apertures and hinges.

Depending upon the design of the securing hardware, the locks / latches can be located in a manner that relates to the visual elements, (e.g. *lever handles*) alternatively, and particularly where common case dimensions for each function are used, securing hardware of this type can be located to the centre mortise position. (As illustrated in Fig. 9.42).

**NOTE 1:** Care should be taken to avoid conflicts between the location of securing hardware and glazed apertures.

**NOTE 2:** For some fire door applications it is necessary to use intumescent gaskets, generally under the lock / latch forend and under strike plates. It is the responsibility of the person fitting hardware to ensure that intumescent gaskets complying with test / assessment data relating to the door leaf construction and / or the particular hardware product, are fitted in accordance with the fire test / assessment data. (See BS 8214 : 2008).

### General Method Locating Locks / Latches:

Fig. 9.42

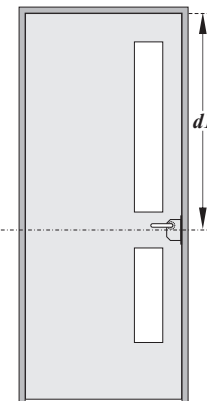

#### **LATCH**

*dI* = Dim. from the top of the door to the centre line of the latch mortise.

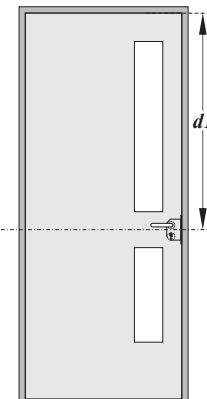

#### **SASHLOCK**

*dI* = Dim. from the top of the door to the centre line of the latch mortise.

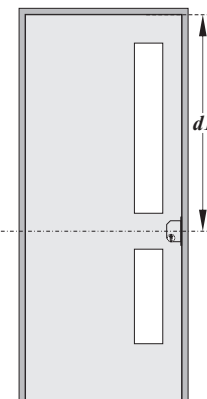

#### **DEADLOCK/ NIGHTLATCH**

*dI* = Dim. from the top of the door to the centre line of the latch mortise.



**Doorset Coordination - Operational Considerations - Door Growth Formula:**

Fig. 9.43

When a door operates it will swing around the axis of the hanging device. The actual operating gap required for the door leaf to clear the frame (or adjacent door if a pair) will vary according to the following formula:

$$= \left[ \sqrt{2(a + b)^2 + (c + d)^2} \right] - a + b$$

- a = Door leaf width.
- b = Dimension from the hanging stile to the pivot centre of the hanging device.
- c = Door leaf thickness.
- d = Dimension from the opening face of the door to the pivot centre of the hanging device.

**NOTE:** Dimensions b & d can be a negative figure for double action doorsets.

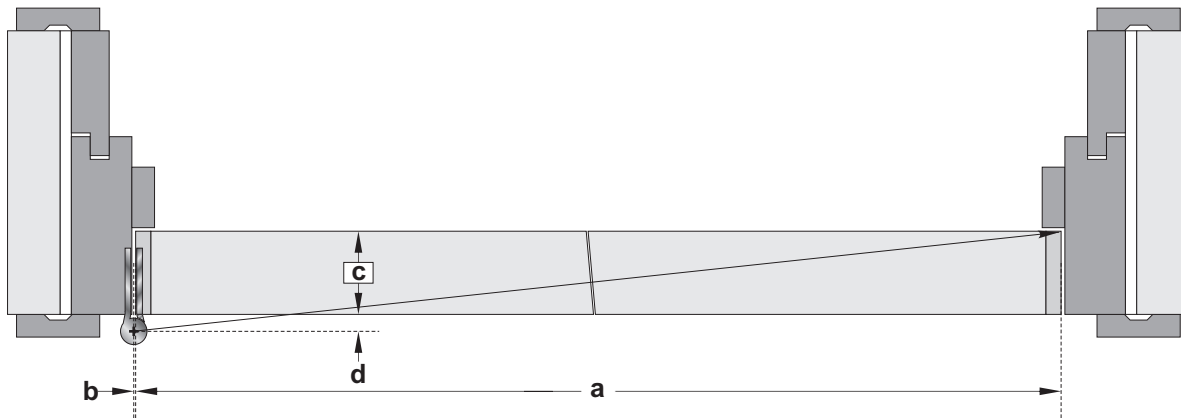

**Adjusting for Door Growth:**

'Door Growth' relates to the throw of the door during its initial movement (until the door leaf clears the frame or the adjacent leaf) from the closed position.

For wide and thin doors it is likely that 'door growth' will not generally give rise to problems as the growth takes place within the operating gaps (with tolerances) provided for by reference to BS4787 Pt.1.

Door Growth can become a problem where thick / narrow doors are used. e.g. a 600mm wide x 54mm thick door hung on single action pivots with a 32mm projection to the pivot centre will require an operating gap of 6 ~ 7mm between the door edge and the closing jamb for the door to clear the frame with a square edged door leaf.

The operating gaps described by reference to BS4787 Pt.1 should always be measured from the opening face of the door excepting at the threshold where the measurement applies at any point within the thickness of the door.

Adjustments to accommodate 'door growth' should be made to suit the particular location and by bevelling the closing stile of the door. This may be referred to as a 'leading edge'.

Some doorset manufacturers offer a 'factory bevel' (leading edge) service as an optional extra. This service usually provides for a fixed 2 ~ 3° bevel that will suit most applications.

**Adjustment for Door Growth:**

Fig. 9.44

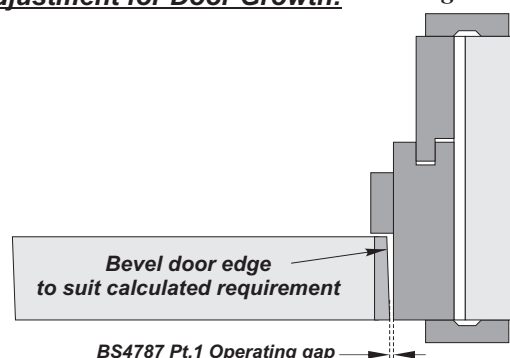



### Method of Handing:

Fig. 9.45

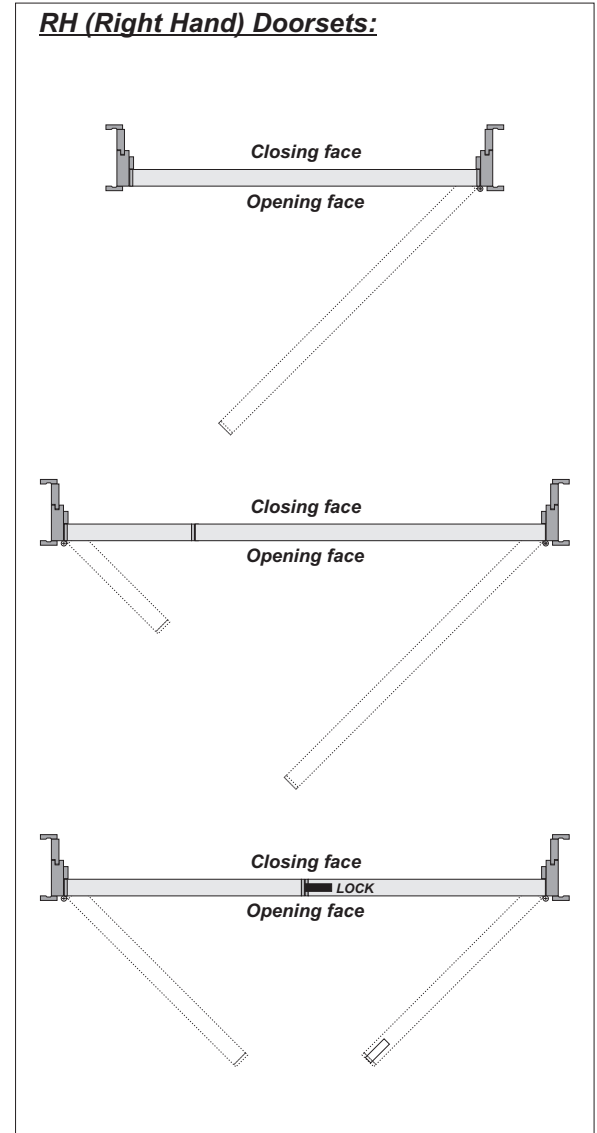
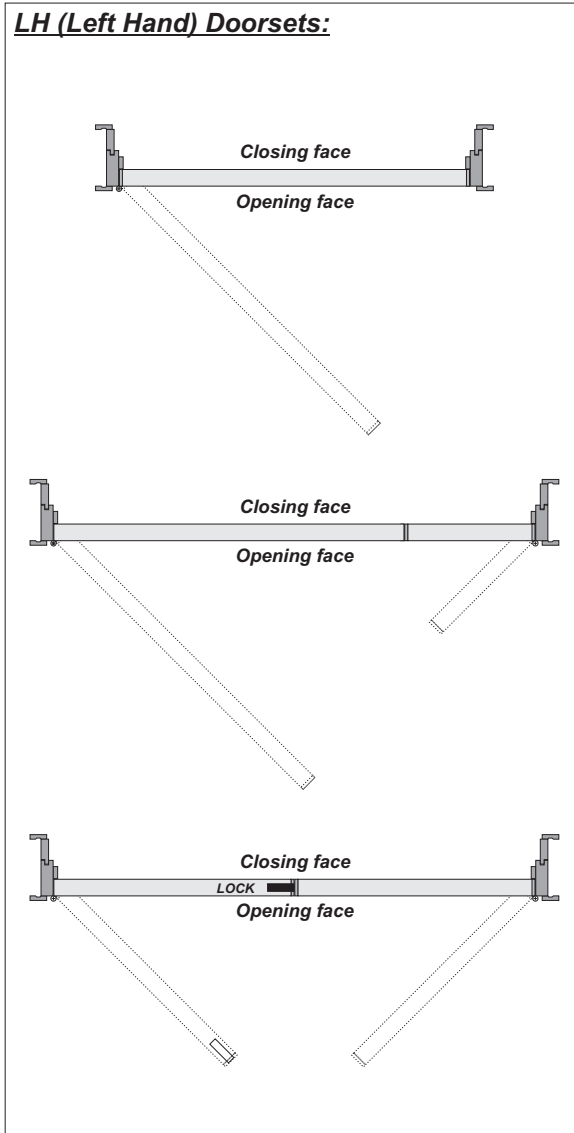

### Method of Handing:

The recommended Method of Handing is culled from BS EN 12519 : 2004 which is extended to include unequal pairs.

When facing the opening face of the door, if the knuckle of the hanging device is to the left then this is a LH (**Left hand**) door. If the knuckle is on the right then this is a RH (**Right hand**) door.

For unequal pairs the doors are handed in the same manner, relative to the wider door leaf.

For equal pairs, the doors are handed in the same manner but related to the 'active' leaf, i.e. first operating leaf. This will generally only apply to rebated pairs but may also apply to doors fitted with a latch or lock with the handing defined to describe which leaf is to be fitted with this hardware.

The 'Opening' and 'Closing' face of a door leaf is defined by reference to BS EN 12519 : 2004 and may provide for a useful reference for doors faced with different materials on each face or for the location of hardware elements e.g. signage.

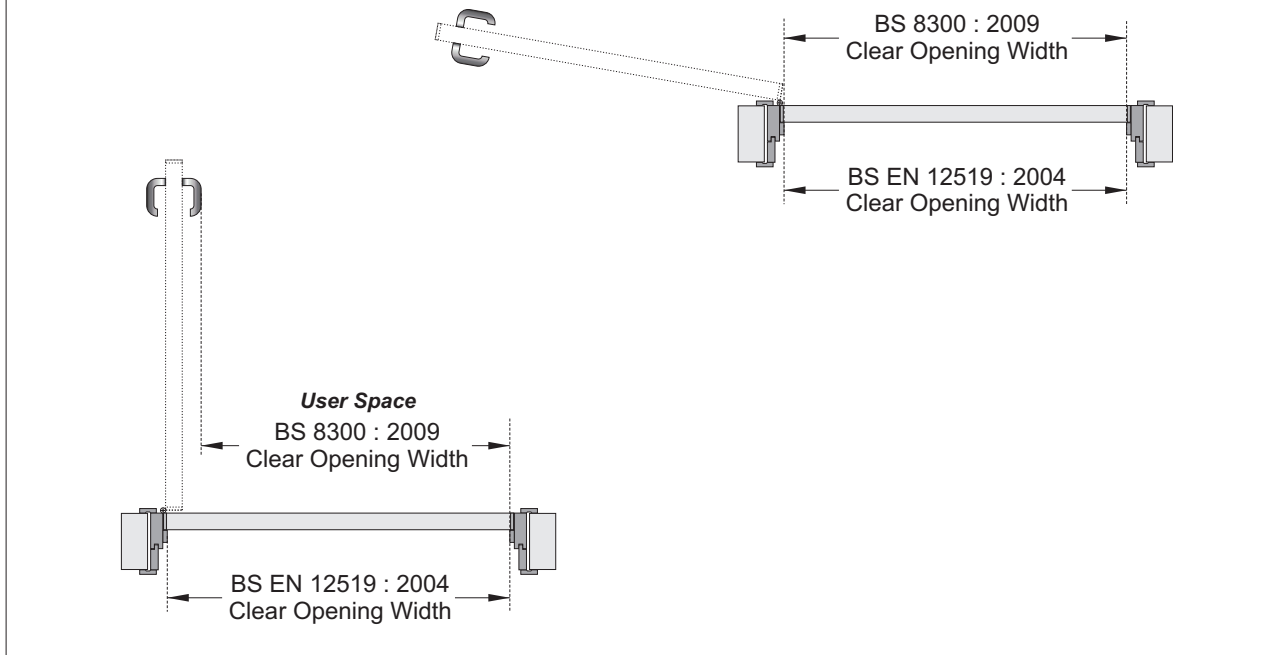
**BS EN 12519 Conflict with BS8300****Fig. 9.46**

**BS EN 12519 Conflict with BS8300 & Building Regulations - (England & Wales) - Approved Document 'M'.**

BS EN 12519 : 2004 defines the clear opening width as a fixed dimension between the faces of the frame door stop.

BS 8300 : 2009 defines the clear opening width as a variable being the effective opening after the deduction of projections into the BS EN 12519 clear opening space. To assist identification, of the requirements, (**pending amendment of these standards**) this document refers to the BS8300 clear opening width as the 'User Space'.

The 'User Space' is a variable that is influenced by the following:

- The position of the door leaf when in the open position.

**NOTE:** If the door is opened to the point where the heel of the door aligns with the face of the hanging jamb doorstop the 'User Space' is equal to the clear opening.

- Door thickness.
- Doorstop dimensions.
- Location of the pivot centre of the hanging device.
- Projection of hardware (**e.g. lever handles**) into the clear opening space.

**NOTE:** Generally this consideration does not apply to single action overhead closers or other devices that would not normally encroach into the 'User Space'.



### **Definitions:**

For the purpose of this document the following definitions apply:

**NOTE:** Definitions are culled from BS EN 12519 : 2004 or by reference to BS6100 documents where possible.

#### **active leaf**

leaf of a multi-leafed door set or door assembly intended to move first to provide opening. Otherwise referred to as the primary leaf. See: BS EN 12519 : 2004

#### **architrave**

trim item used to cover installation gaps between the frame and the surrounding structure. See: BS EN 12519 : 2004

#### **clear opening dimension**

the clear opening width is the dimension from the face of the doorstop on one jamb to the corresponding position at the opposite jamb.

The clear opening height is the dimension from the bottom of the head door stop to the top of the finished floor level. See: BS EN 12519 : 2004

**\* NOTE:** For BS8300 - Provision for the Disabled - The clear opening width is defined as above for doors that open more than 90°. For doors that are restricted to open to 90° the clear opening width is further defined as above less half the thickness of the door leaf, less the dimension of the projection of any ironmongery into the 'traffic' space.

#### **clear glass opening (cgo)**

the area of a glazed aperture after glazing bead has been fitted. (Not defined)

#### **closing face**

the face of a single action door that contacts the door stop when the door is closed. See: BS EN 12519 : 2004

#### **coordinating dimensions**

theoretical design dimensions used for the coordination of building elements including nominal opening height and width dimensions of openings to receive doorsets or door assemblies. See: BS EN 12519 : 2004

#### **coordinating height (transoms & over panels):**

the dimension from the bottom of the frame jamb to the top of a transom rail, measured at the door leaf position OR the dimension from the bottom of the frame jamb to the under side of an over panel measured relative to the opening face of the door leaf, at the time of manufacture. Not Defined

**NOTE:** Relevant to storey height assemblies only.

#### **cover fillet**

fillet to cover a joint in joinery or between joinery and the adjoining work. See quadrant BS6100-4.4

#### **DATUM**

fixed position in height above the nominal floor level used as a reference by a doorset manufacturer (and other trades) for the determination of doorset dimensions and doorset component location dimensions to ensure alignment of components with adjacent doorsets. See Precision Projects Pages 8.23 & 8.24 - Not defined

#### **door assembly**

complete assembly as installed, including door frame and one or more leaves, together with its essential hardware supplied from separate sources. See: BS EN 12519 : 2004

#### **door bottom rail**

the bottom edge of a door leaf See: BS EN 12519 : 2004

#### **door frame**

part of the door assembly from which the doors hang. See: BS EN 12519 : 2004 & BS6100-1.3.5

#### **door growth**

the extent of the movement in the horizontal plane that a door requires to clear a frame jamb (or adjacent leaf if a double leaf doorset) during operation. This is a variable related to the door leaf width, door leaf thickness and the location of the pivot centre around which the door swings. Related to Operating gaps. Not defined - See leading edge.

#### **door head**

the top edge of a door leaf See: BS EN 12519 : 2004

#### **door height door set**

a door set or door assembly without an over panel or fanlight. Not defined

#### **door leaf**

hinged, pivoted or sliding part of a door assembly or door set. See: BS EN 12519 : 2004 & BS6100-1.3.5

#### **door leaf height**

the overall height of a door leaf at the time of manufacture. See: BS EN 12519 : 2004

#### **door leaf width**

the overall width of a door leaf at the time of manufacture. See: BS EN 12519 : 2004

#### **door leaf thickness**

the thickness of a door leaf, at the frame rebate position, excluding any beading or planted decoration at the time of manufacture. Not defined



### **Definitions contd:**

#### **door set / doorset**

complete unit consisting of a door frame and a leaf or leaves, supplied with all essential parts from a single source. See: *BS EN 12519 : 2004 & BS6100-1.3.5*

#### **doorset - 'knock down'**

frames are supplied separately with frame jambs / heads & transom rails cut to size and factory jointed for site assembly. Frames are not prepared to receive hardware. Loose doorstop and architrave supplied over length to be cut to size and jointed on site. Door leaves are supplied separately and may be edge machined only (*where specified*) for non projecting hardware.

#### **doorset - 'doorset kit'**

doors and frames supplied as describe for doorset 'knock down' but delivered at the same time and packed into location kits that may include specified items of hardware.

#### **door stile**

the vertical edges of a door leaf. See: *BS EN 12519 : 2004 & BS6100-4.4*

#### **door stop**

an element of a door frame that limits the swing of a single action door leaf. See: *BS EN 12519 : 2004 & BS6100-1.3.5 & 4.4*

#### **double action door**

hinged or pivoted door that can be opened in either direction See: *BS EN 12519 : 2004*

#### **double leaf doorset**

otherwise referred to as a pair of doors where two door leaves are used in a single plane with each leaf attached to a different jamb. See: *BS EN 12519 : 2004 & BS6100-1.3.5 (Conflicting definitions)*

#### **double door doorset**

otherwise referred to a 'back to back' doorsets where two doors are hung from a single frame with coordinating width dimensions suitable for a single leaf doorset. See: *BS EN 12519 : 2004*

#### **equal pair**

a double leaf doorset where each leaf is of equal width. *Not defined*

#### **extension lining**

a frame component added to the frame lining to extend the dimensions of the frame to suit a specified frame partition thickness. *Not defined*

#### **external door**

a door leaf that is directly exposed to external environmental conditions on one or both sides of the door leaf. See: *BS EN 12519 : 2004 & BS6100-1.3.5*

#### **fanlight**

the space between a frame transom rail and the frame head that is generally glazed. See: *BS EN 12519 : 2004 & BS6100 1-3.5 & BS6100-1.3.5*

#### **finished floor level**

the level above or below the nominal floor level resulting from the application of finishes and / or other building design considerations related to finished floor levels. Floor finishes may include carpet, vinyl or ceramic tiles, wood or laminate flooring etc. *Not defined*

#### **flush door (leaf)**

a fabricated door leaf that is flush on both faces of the door leaf. See: *BS EN 12519 : 2004 & BS 6100-1.3.5*

#### **flush over panel**

a panel located between a door leaf and a frame head to provide for storey height door sets when used without a transom rail. *Not defined*

#### **frame jamb**

the vertical outer components of a door frame. See: *BS EN 12519 : 2004 & BS6100-1.3.5*

#### **frame lining**

the primary frame jamb and head components of a door frame that form the outer perimeter of a door set or door assembly before the addition of architrave extension linings etc. *BS6100-1.3.5*

#### **frame mullion**

a vertical section of a door frame that is located between the frame jambs. See: *BS EN 12519 : 2004 & BS6100-1.3.5*

#### **frame nominal opening width / height**

the dimensions between the faces of a frame at the frame reveal (*at the door leaf position*) in width and from the bottom of the frame jambs or top of a sill to the frame reveal (*at the door leaf position*) at the frame head or transom rail. See shoulder dimensions. See: *BS EN 12519 : 2004*

#### **frame nose dimension**

the visible part of a frame in elevation when viewed from the opening face of a door set or door assembly when the door is in the closed position before the addition of architrave. *Not defined*



## Definitions contd:

### **frame partition thickness**

the overall dimension of the frame, including extension linings but excluding architrave. May be different to the wall partition thickness. *Not defined*

### **frame rebate**

the section formed in a frame to create a housing to receive a single action door leaf. *BS6100-4.4*

### **frame reveal**

the dimension from the nose of the frame to the face of the doorstep. This is related to the door leaf thickness and may vary for any given door thickness to accommodate sealing systems or the extent to which the door leaf is to be set back from the face of the frame. The internal side surfaces of a door frame at the door leaf position. *BS6100-1.3.5*

### **frame sill**

a frame component that is jointed to the frame jambs at the bottom of a door set or door assembly. *See: BS EN 12519 : 2004 & BS6100-1.3.5*

### **frame transom**

a horizontal frame section that is jointed to the frame jambs at a position between the door leaf and the frame head to provide for extended height door sets / door assemblies. *See: BS EN 12519 : 2004 & BS6100-1.3.5 & 4.4*

### **frame width / height**

the overall width of a frame excluding architrave in width. the overall dimension from the bottom of the frame jambs and / or bottom of a sill if used to the top of the frame head excluding architrave. *See: BS EN 12519 : 2004*

### **glazing bead**

door components used to secure glass in a door leaf or frame. *See: BS EN 12519 : 2004*

### **glazing system**

complete system including linings, gaskets, seals and beading required to secure glass in a door leaf or door frame. *Not defined*

### **hardware**

door set / door assembly components usually in metal that are fitted to a door or frame to provide for the operation and securing of a door leaf. *Not defined*

### **inactive leaf**

leaf of a multi-leafed doorset or door assembly, intended to be moved after the active leaf. Otherwise referred to as the secondary leaf. *See: BS EN 12519 : 2004*

### **installation gaps**

the spaces required between a door frame and a surrounding structure to provide for the installation of 2nd. fix door sets. *Not defined*

### **internal door**

a door leaf located between two internal spaces. *See: BS EN 12519 : 2004 & BS6100-1.3.5*

### **ironmongery**

See hardware *Not defined*

### **left hand door**

door which opens with a rotating movement with the hinge position on the left hand side when viewed from the opening face. When viewed on plan the door will move in a clockwise direction. *See: BS EN 12519 : 2004*

### **joinery door**

a door leaf constructed of solid timber components that are jointed together. *BS6100-4.4*

### **leading edge**

the bevelling of the closing stile of the door leaf to accommodate 'door growth' in operation. See door growth.

*NOTE: The leading edge is generally applied by the installation contractor to suit the requirements for each location. However, some manufacturers offer a factory applied 'leading edge' facility as an optional extra.*

### **moulded door stop**

a door stop that is machined from a single piece of timber and which is an integral part of that frame jamb, head or transom. (*Suitable for use with door leaves of a known or fixed thickness*). *See door stop. BS6100-4.4*

### **nominal floor level**

a coordinating level used for determining a prepared opening height and the level for applied floor finishes. *See: BS EN 12519 : 2004*

### **non projecting hardware**

items of hardware that can be fitted within the thickness of the door leaf without projecting beyond the face of the door. *Not defined*

*NOTE: Butt hinges are generally considered as being non projecting items of hardware.*

### **operating gaps**

the gap dimensions between a door leaf and a frame or an adjacent door that are necessary to ensure that the door leaves do not contact with the frame or adjacent door during the operation of the door leaves. *Not defined*



### Definitions contd:

#### **over panel**

a panel, usually constructed to the same details as a door leaf to fill a space above a door leaf when used with storey height door sets or door assemblies. *Not defined*

#### **panelled door / glazed door leaf**

a flush door that is cut to form glazing apertures or to receive panels OR a joinery door fabricated to form glazing apertures or a space to receive panels. See: *BS EN 12519 : 2004 & BS6100-1.3.5*

#### **performance door sets**

the basic function of a door set is to provide a facility for 'traffic' to pass from one side of a wall to another. The term 'Performance door set' is used where a secondary performance is required. Secondary performances may include: fire, smoke sealing, sound attenuation, air permeability, weather sealing, etc. *Not defined*

#### **planted door stop**

a door stop that is added as a separate component to the frame jamb, head and / or transom (*suitable for use with door leaves of an unknown or variable thickness*). *BS6100-4.4*

#### **precision projects**

projects where structural and design considerations require a high level of accuracy and precise dimensions for the purpose of manufacturing door set components. All details necessary to determine precise dimensions must be known to the door set / assembly manufacturer in advance of the commencement of manufacture. *Not defined*

#### **prepared opening**

the opening (*height, width and thickness*) in a building that is prepared by the builder to receive door sets / door assemblies of the designed details and dimensions. The prepared opening dimensions may be the same as the structural opening dimensions or related to the coordinating dimensions by reference to BS EN 12519 : 2004 according to the nature of the design of the structure. *Not defined*

#### **primary leaf**

See *active leaf*

#### **quadrant**

a trim item usually used in conjunction with architraves to cover installation tolerances at a junction between components. See *cover fillet*

#### **rebate depth (frame)**

See *frame reveal*.

#### **right hand door**

door which opens with a rotating movement with the hinge position on the right hand side when viewed from the opening face. When viewed on plan the door will move in an anti-clockwise direction. See: *BS EN 12519 : 2004*

#### **secondary leaf**

See *inactive leaf*. *Not defined*

#### **sequential opening**

a term used in connection with double leaf door sets to identify a requirement that door leaves should be operated in sequence. See *active leaf*. *Not defined*

#### **'shooting'**

a trade term to describe the adjustment of door leaves by planing or otherwise easing to ensure the correct operation of a door leaf *Not defined*

#### **shoulder dimensions**

a trade term to describe the internal dimensions of a door frame at the door leaf and or panel positions at the time of manufacture.

**NOTE:** *This is the same as the Frame Nominal opening for width. For height; the shoulder height is the dimension from the bottom of the jambs (or top of the sill) to the under side of the frame head at the door position for door height doorsets. A second shoulder height is defined for storey height doorsets from the bottom of the jambs (or top of a sill) to the under side of a transom at the door leaf position.*

#### **simultaneous opening**

a term used in connection with double leaf door sets to describe a requirement where the door leaves may be operated in any sequence or at the same time. *Not defined*

#### **single action door**

hinged or pivoted door that can be opened in one direction only See: *BS EN 12519 : 2004*

#### **sill**

See *frame sill*

#### **solid door stop**

a door stop that is machined from a single piece of timber and which is an integral part of that frame jamb, head or transom. (*Suitable for use with door leaves of a known or fixed thickness*). See *door stop*. *BS6100-4.4 - See moulded doorstop*.





**Definitions contd:**

**storey height door set**

a door set or door assembly that is of extended height generally to fill a full floor to ceiling space and that may be constructed using flush or transomed over panels or fanlights. *Not defined*

**structural reveal**

side surfaces of an opening in a wall. *See: BS EN 12519 : 2004*

**threshold**

the space at the bottom of a door set or door assembly under the door leaf when the door is in the closed position. *See: BS EN 12519 : 2004 & BS6100-1.3.5*

**threshold strip**

a component that is not part of a frame that is located under the door when the door is in the closed position. A threshold strip may be in any material and may be profiled and / or rebated. *See BS6100-1.3.5 alternative to threshold*

**'traffic'**

the users of a doorway including persons and equipment. *Not defined*

**transomed over panel**

a panel used above a door leaf in a space created between a transom rail and a frame head in a storey height doorset. *Not defined*

**unequal pair**

a double leaf doorset where one of the leaves (*usually the active leaf*) is wider than the other leaf. *Not defined*

**This Section is an advisory document only included to assist users of FLAMEBREAK®.**



Architectural & Specialist Door Manufacturers Association

Burnside House,  
3 Coates Lane,  
High Wycombe,  
Buckinghamshire HP13 5EY

Tel: 01494 447370  
Fax: 01494 462094

e-mail: [specialdoors@googlemail.com](mailto:specialdoors@googlemail.com)

web site: [www.asdma.com](http://www.asdma.com)

